

PBLR95FHS Series

Frameless Brushless DC Motor

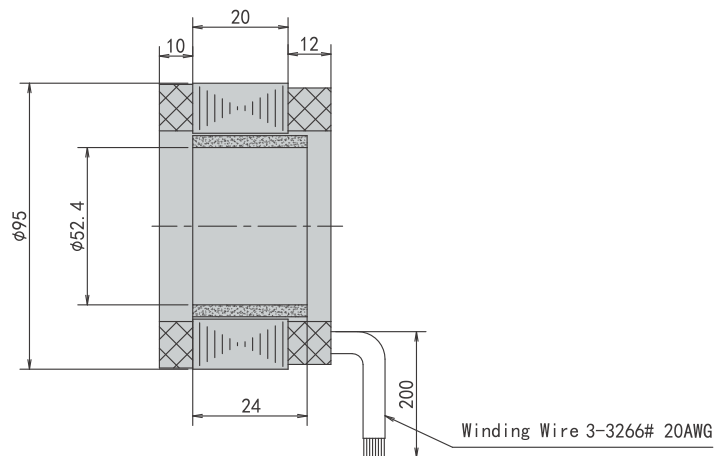

General Specifications

Winding Type	Star/Delta
Dielectric Strength	600VAC/1S
Insulation Resistance	100M Ω ,500VDC
Ambient Temperature	-20°C~+50°C
Insulation Class	Class B

Electrical Specifications

Motor Model	Unit	PBLR95FHS486230
Number of Phase		3
Number of Poles		16
Rated Voltage	VDC	48
Rated Speed	Rpm	3000
Rated Torque	N.m	2.0
Rated Power	W	628
Rated Current	A	17.5
Peak Current	A	52.5
Peak Torque	N.m	6.0
Rotor Inertia	kg.cm ²	0.52
Torque Constant	N.m/A	0.11
Torque Constant	V/krpm	10.5
Line-Line Resistance	Ω	0.4
Line-Line Inductance	mH	0.8
Length	mm	20
Weight	kg	1.3