

# PBLR60FHS Series

## Frameless Brushless DC Motor

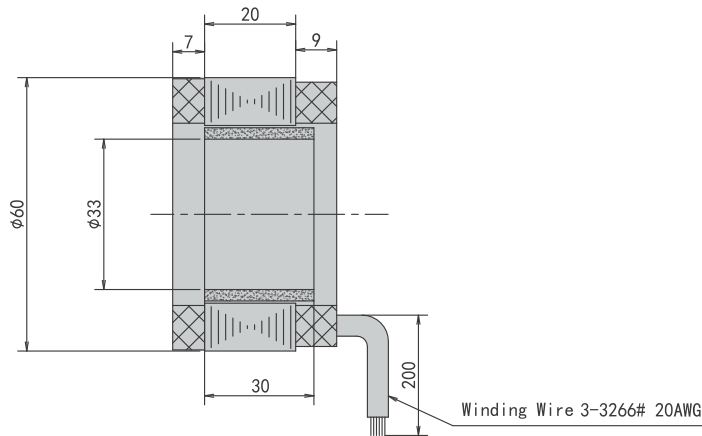

### General Specifications

Winding Type	Star/Delta
Dielectric Strength	600VAC/1S
Insulation Resistance	100M $\Omega$ ,500VDC
Ambient Temperature	-20°C~+50°C
Insulation Class	Class B

### Electrical Specifications

Motor Model	Unit	PBLR60FHS481530
Number of Phase		3
Number of Poles		16
Rated Voltage	VDC	48
Rated Speed	Rpm	3000
Rated Torque	N.m	0.5
Rated Power	W	157
Rated Current	A	4.4
Peak Current	A	13.2
Peak Torque	N.m	1.5
Rotor Inertia	kg.cm <sup>2</sup>	0.15
Torque Constant	N.m/A	0.1
Torque Constant	V/krpm	9.5
Line-Line Resistance	$\Omega$	1.0
Line-Line Inductance	mH	1.8
Length	mm	20
Weight	kg	0.7