

Features

- Max Junction Temperature 150°C
- High breakdown voltage up to 650V for improved reliability
- Short Circuit Rated
- Very Low Saturation Voltage:
 $V_{CE(SAT)} = 1.65V$ (Typ.) @ $I_C = 15A$
- Soft current turn-off waveforms

V_{CE}	650	V
I_C	15	A
V_{CE(SAT)} I_C=15A	1.65	V

Applications

- Soft switching applications
- Air conditioning
- Motor drive inverter

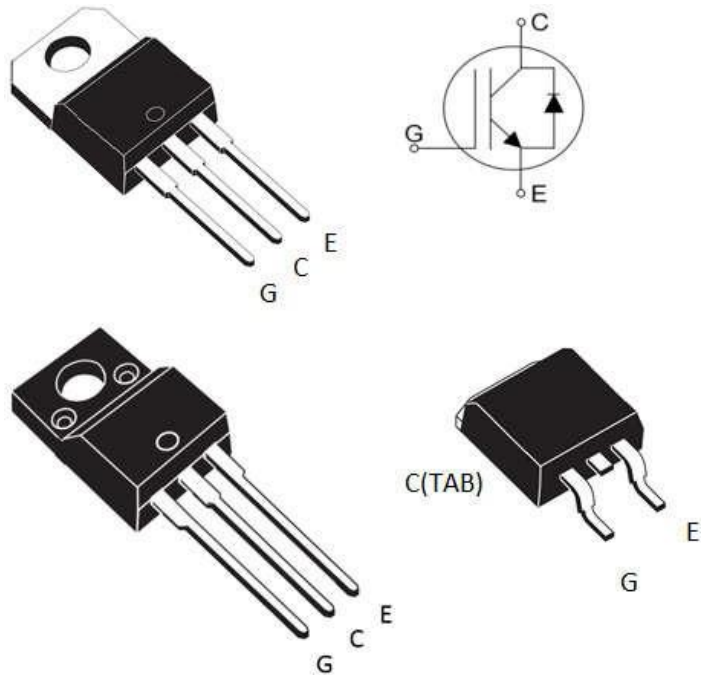

Product	Package	Packaging
YZPST-15N65T1	TO-220	Tube
YZPST-15N65T1	TO-263	Tube
YZPST-15N65T1	TO-220F	Tube



Tel: +86-514-87782298, 87782296

FAX: +86-514-87782297, 87367519

E-mail: positioning@china.com;

info@yzpst.com;

yzpst@pst888.com

Web Site: www.Pst888.com

www.yzpstcc.com

www.yzpst.net

www.yzpst.com

Maximum Ratings (T_j= 25°C unless otherwise specified)

Parameter	Symbol	Value	Unit
Collector-Emitter Breakdown Voltage	V _{CE}	650	V
DC collector current, limited by T _{jmax} T _C = 25°C T _C = 100°C	I _C	30 15	A
Diode Forward current, limited by T _{jmax} T _C = 25°C T _C = 100°C	I _F	30 15	A
Continuous Gate-emitter voltage	V _{GE}	±20	V
Transient Gate-emitter voltage	V _{GE}	±30	V
Turn off safe operating area V _{CE} ≤ 650V, T _j ≤ 150°C	-	60	A
Pulsed collector current, V _{GE} =15V, t _p limited by T _{jmax}	I _{CM}	45	A
Short Circuit Withstand Time, V _{GE} = 15V, V _{CE} ≤ 400V	T _{sc}	5	μs
TO-220F Power dissipation , T _j =25°C	P _{tot}	27	W
TO-220,TO-263, Power dissipation , T _j =25°C	P _{tot}	105	W
Operating junction temperature	T _j	-40...+150	°C
Storage temperature	T _s	-55...+150	°C
Soldering temperature, wave soldering 1.6mm (0.063in.) from case for 10s	-	260	°C

Thermal Resistance

Parameter	Symbol	TO-220,TO-263	TO-220F	Unit
IGBT thermal resistance, junction - case	R _{θ(j-c)}	1.2	4.9	K/W
Diode thermal resistance, junction - case	R _{θ(j-c)}	2.38	5.8	K/W
Thermal resistance, junction - ambient	R _{θ(j-a)}	62.5		K/W



Electrical Characteristics of the IGBT ($T_j = 25^\circ\text{C}$ unless otherwise specified)

Symbol	Parameter	Test Conditions	Min.	Typ.	Max.	Units
Static Characteristics (Tested on wafers)						
BV_{CES}	Collector to Emitter Breakdown Voltage	$V_{GE} = 0V, I_c = 1mA$	650	-	-	V
$V_{CE(SAT)}$	Collector to Emitter Saturation Voltage	$I_c = 15A, V_{GE} = 15V$	-	1.65	1.95	V
$V_{GE(th)}$	G-E Threshold Voltage	$V_{GE} = V_{CE}, I_c = 250\mu A$	4.1	5.0	5.7	V
I_{CES}	Collector Cut-Off Current	$V_{CE} = 650V, V_{GE} = 0V$	-	-	25	μA
I_{GES}	G-E Leakage Current	$V_{GE} = \pm 20V, V_{CE} = 0V$	-	-	± 200	nA
g_{fs}	Transconductance	$V_{CE}=20V, I_c=15A$	-	10	-	S

Parameter	Symbol	Conditions	Min	Typ	Max	Unit
Dynamic						
Input capacitance	C_{ies}	$V_{CE} = 25V, V_{GE} = 0V,$ $f = 1MHz$	-	990	-	pF
Output capacitance	C_{oes}		-	56	-	
Reverse transfer capacitance	C_{res}		-	30	-	
Gate charge	Q_G	$V_{CC} = 480V, I_c = 15A,$ $V_{GE} = 15V$	-	92	-	nC
Short circuit collector current	$I_{C(SC)}$	$V_{GE}=15V, t_{SC} \leq 5\mu s$ $V_{CC}=400V,$ $T_{j, start}=25^\circ C$	-	98	-	A

Switching Characteristic, Inductive Load ($T_j = 25^\circ\text{C}$ unless otherwise specified)

Parameter	Symbol	Conditions	Min.	Typ.	Max.	Unit
Dynamic						
Turn-on Delay Time	$t_{d(on)}$	$T_j = 25^\circ\text{C}$ $V_{CC} = 400\text{V}$, $I_C = 15\text{A}$, $V_{GE} = 0/15\text{V}$, $R_g = 12\ \Omega$	-	15	-	ns
Rise Time	t_r		-	25	-	ns
Turn-off Delay Time	$t_{d(off)}$		-	60	-	ns
Fall Time	t_f		-	46	-	ns
Turn-on Energy	E_{on}		-	0.75	-	mJ
Turn-off Energy	E_{off}		-	0.1	-	mJ

Electrical Characteristics of the DIODE ($T_j = 25^\circ\text{C}$ unless otherwise specified)

Parameter	Symbol	Conditions	Min	Typ	Max	Unit
Dynamic						
Diode Forward Voltage	V_{FM}	$I_F = 15\text{A}$	-	1.7	-	V
Reverse Recovery Time	T_{rr}	$I_F = 15\text{A}$ $V_R = 300\text{V}$, $di/dt = 200\text{A}/\mu\text{s}$	-	50	-	ns
Reverse Recovery Current	I_{rr}		-	4	-	A
Reverse Recovery Charge	Q_{rr}		-	83	-	nC

Fig. 1 FBSOA characteristics for TO-220F

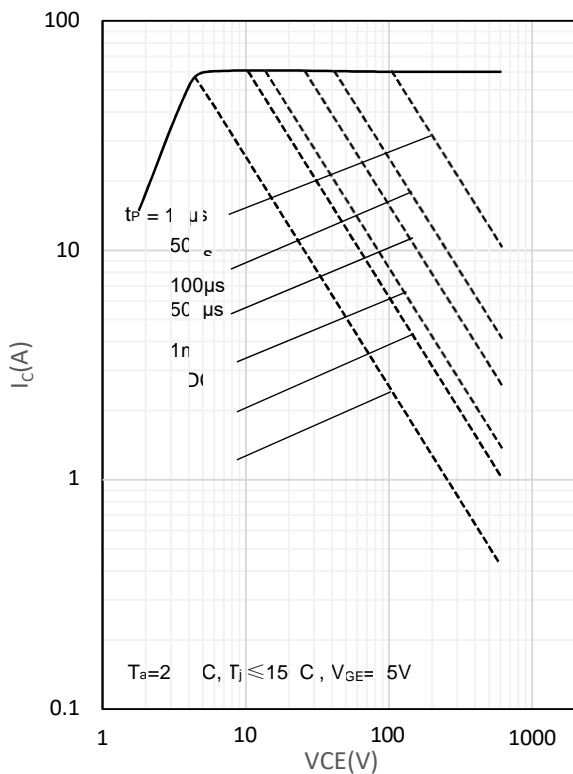

Fig. 2 FBSOA characteristics for TO-220 and TO-263

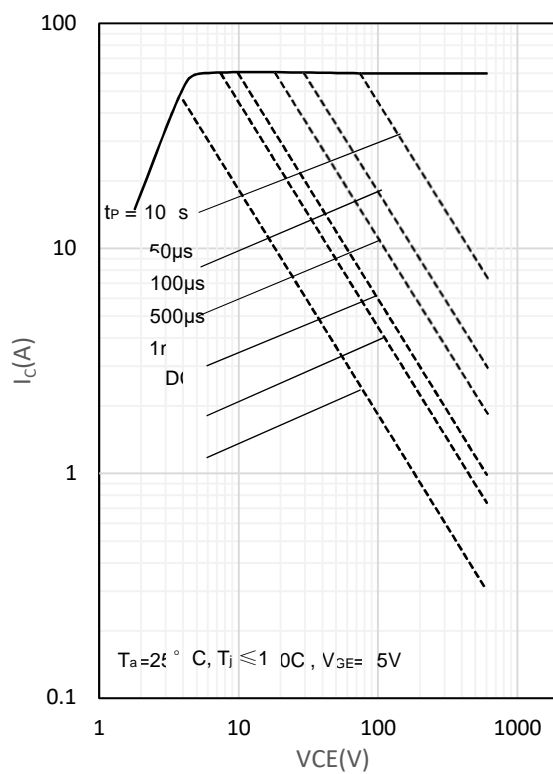

Fig. 3 Load Current vs. Frequency for TO-220F

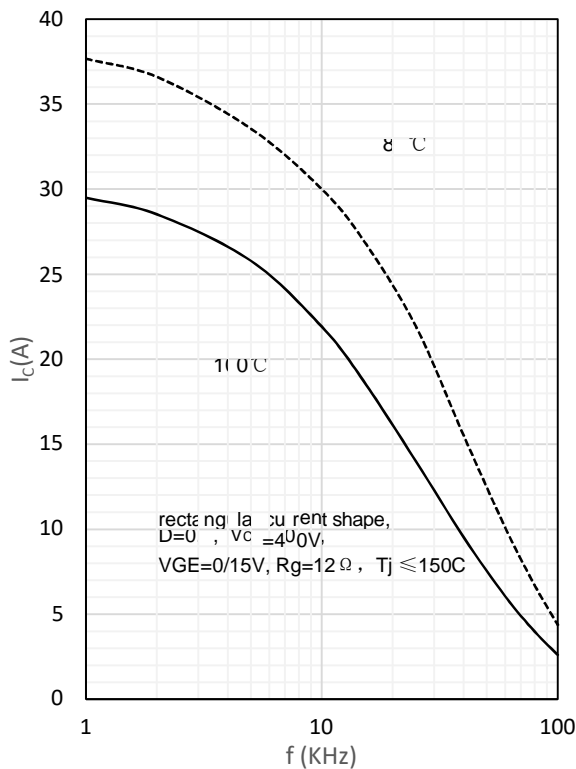

Fig.4 Load Current vs. Frequency TO-220 and TO-263

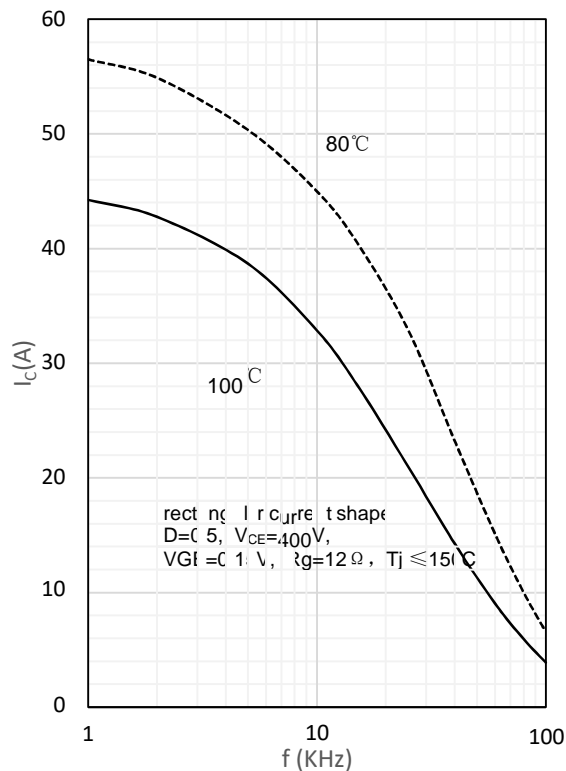

Fig. 5 Output characteristics

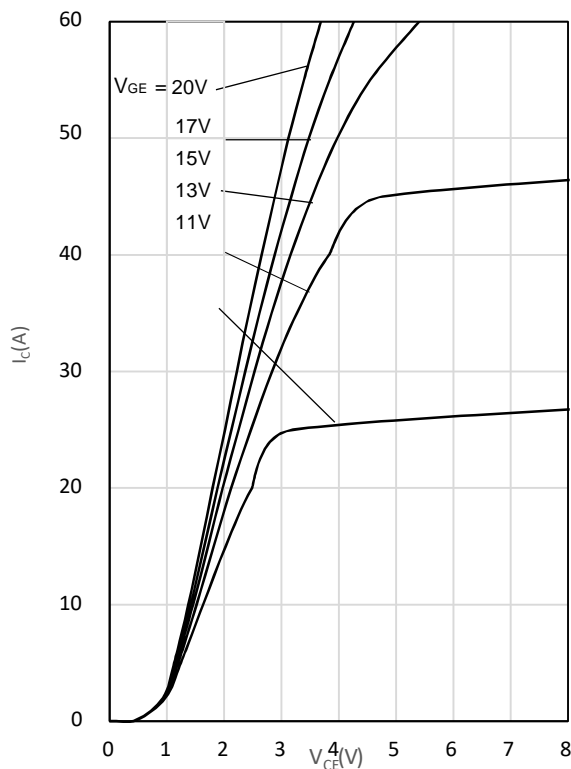

Fig. 6 Saturation voltage characteristics

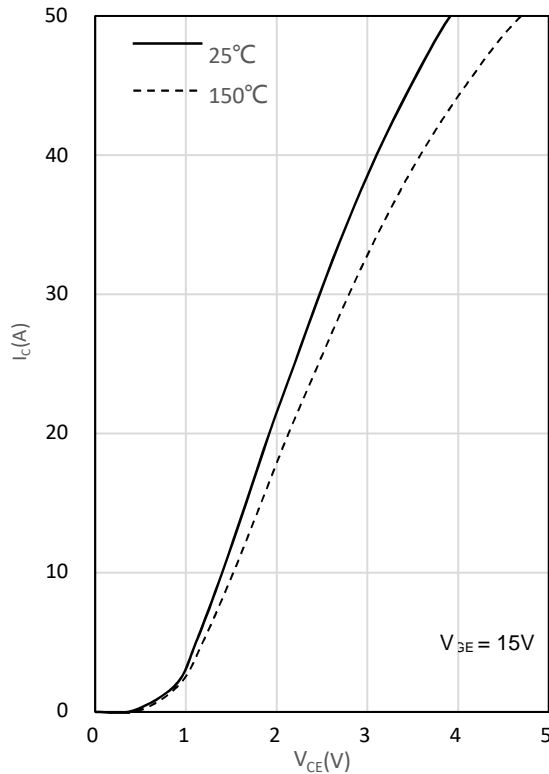

Fig. 7 Switching times vs. gate resistor

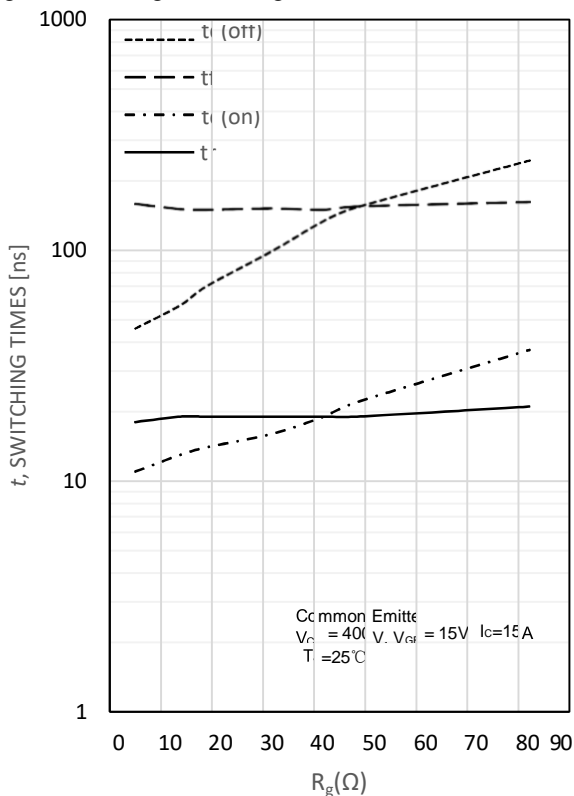

Fig. 8 Switching times vs. collector current

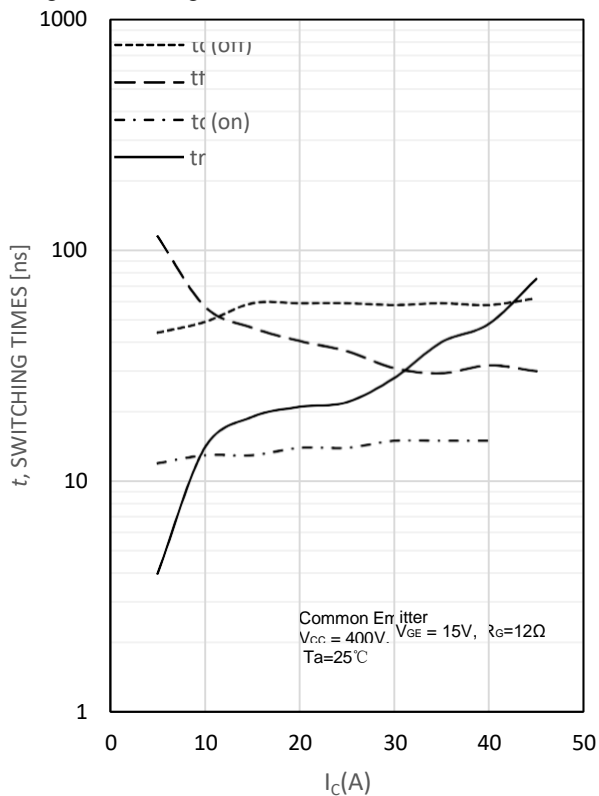

Fig. 9 Switching loss vs. gate resistor

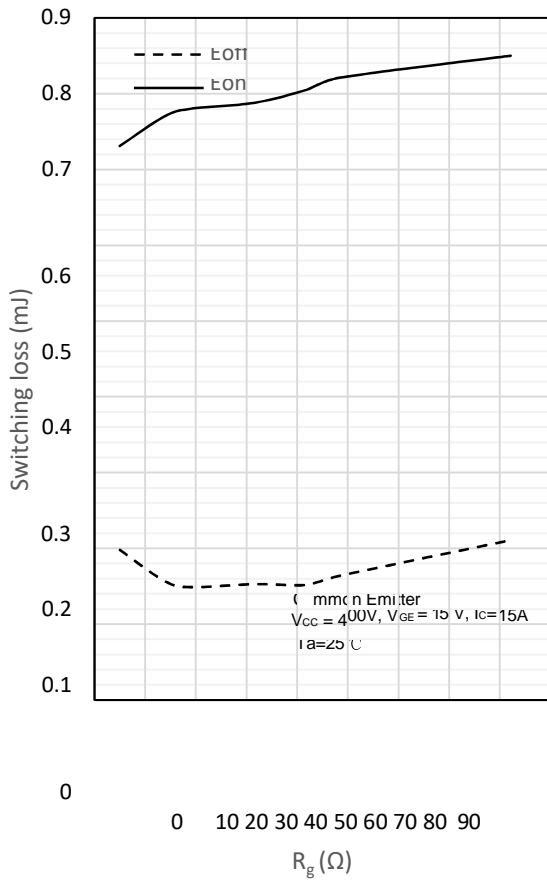

Fig. 10 Switching loss vs. collector current

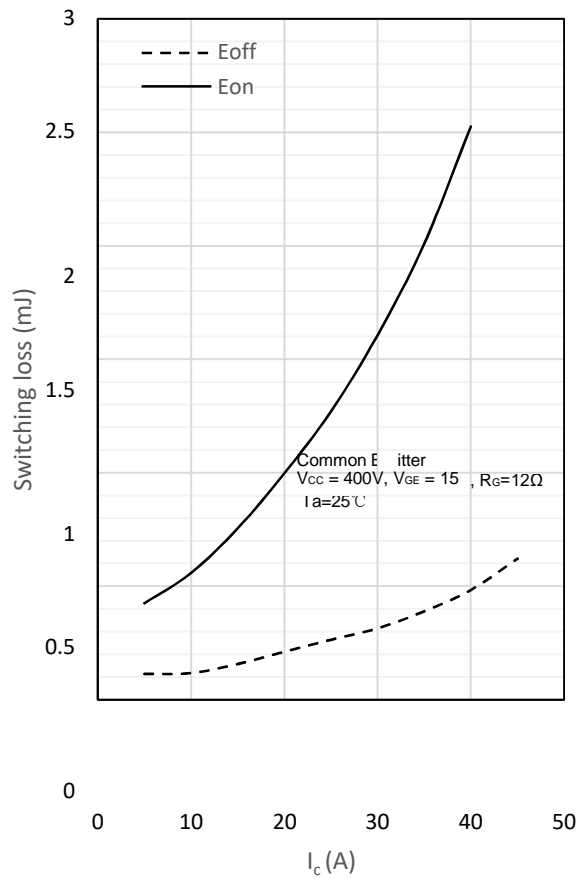

Fig. 11 Gate charge characteristics

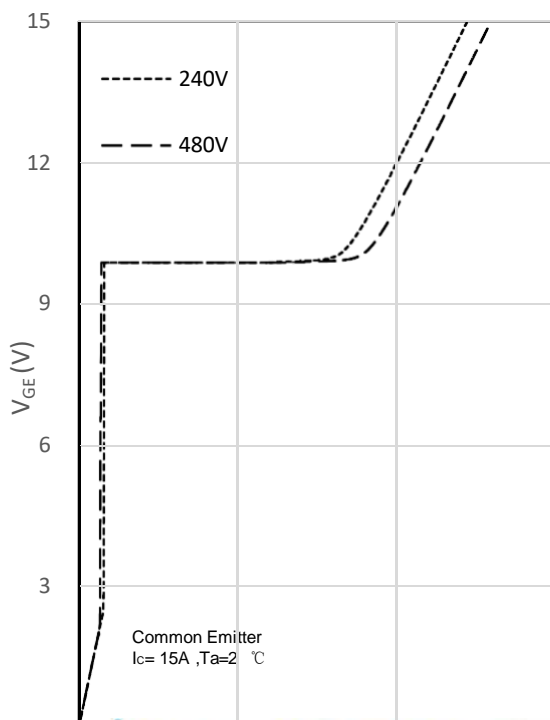
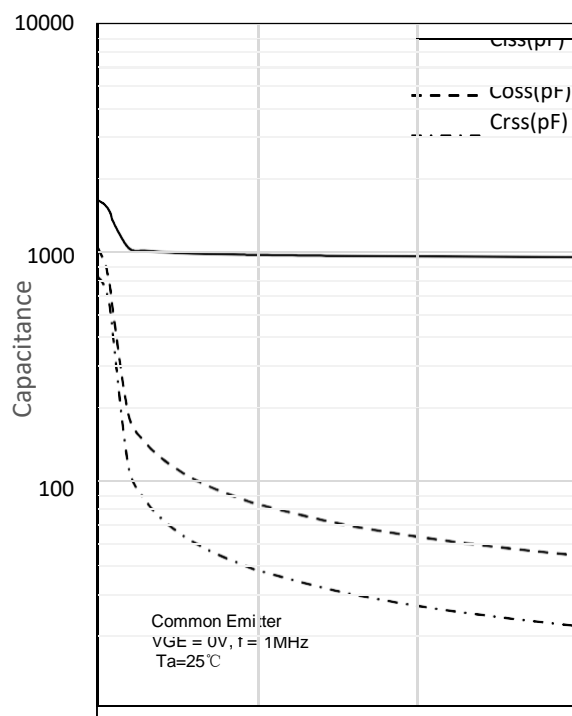
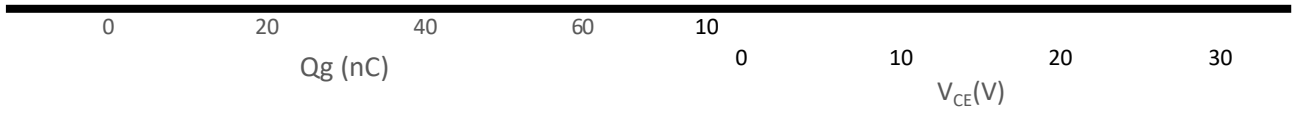
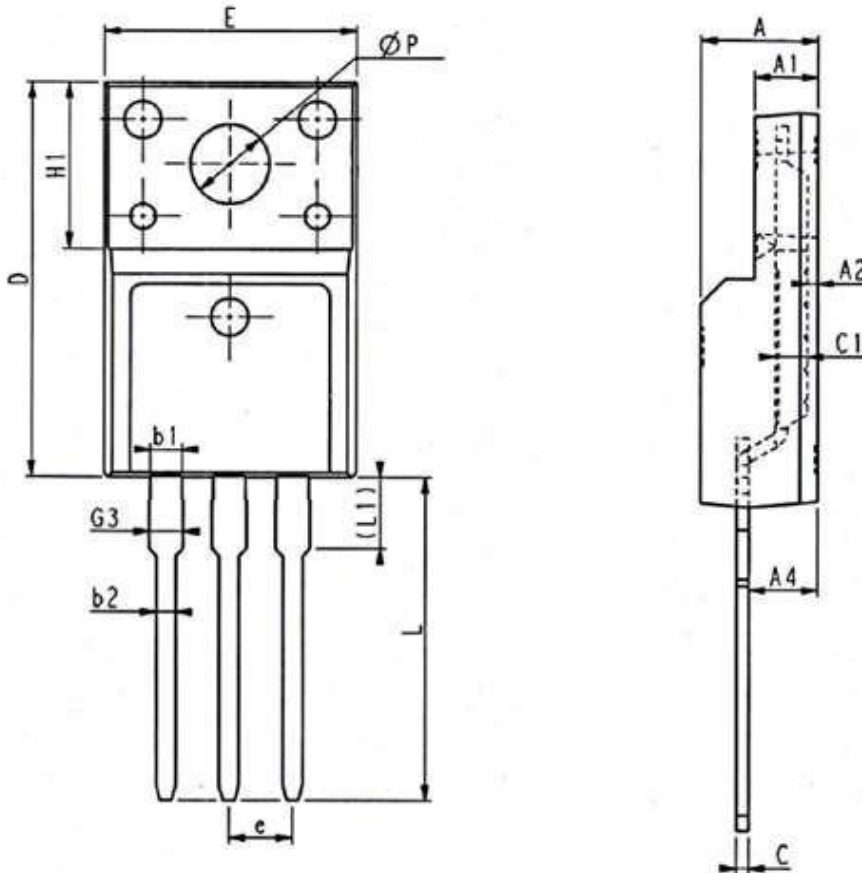

Fig. 12 Capacitance characteristics





TO-220F package information



SYMBOL			
	MIN	NOM	MAX
E	9.96	10.16	10.36
A	4.50	4.70	4.90
A1	2.34	2.54	2.74
A2	0.30	0.45	0.60
A4	2.56	2.76	2.96
c	0.40	0.50	0.65
c1	1.20	1.30	1.35
D	15.57	15.87	16.17
H1	6.70REF		
e	2.54BSC		
L	12.68	12.98	13.28
L1	2.88	3.03	3.18
ΦP	3.03	3.18	3.38
$\Phi P3$	3.15	3.45	3.65
F3	3.15	3.30	3.45
G3	1.25	1.35	1.55
b1	1.18	1.28	1.43
b2	0.70	0.80	0.95

TO-263 package information

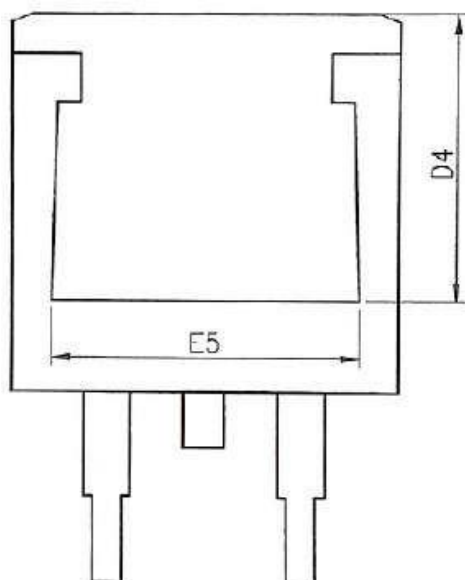
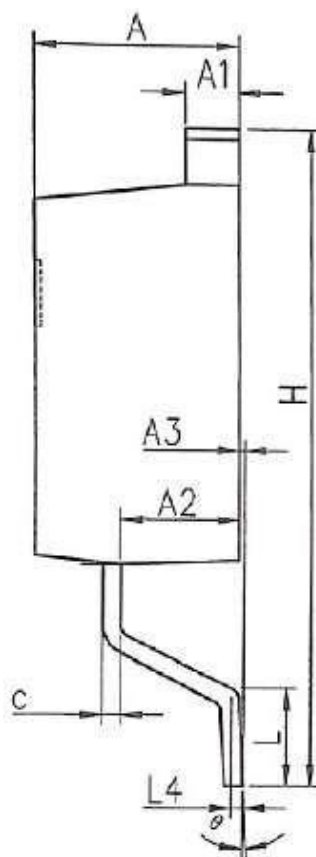
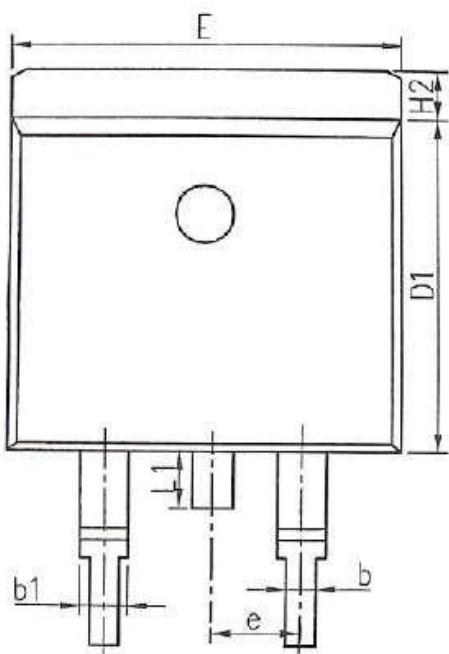

SYMBOL	MM		
	MIN	NOM	MAX
A	4.37	4.57	4.77
A1	1.22	1.27	1.42
A2	2.49	2.69	2.89
A3	0.00	0.13	0.25
b	0.70	0.81	0.96
b1	1.17	1.27	1.47
c	0.30	0.38	0.53
D1	8.50	8.70	8.90
D4	6.60	-	-
E	9.86	10.16	10.36
E5	7.06	-	-
e	2.54 BSC		
H	14.70	15.10	15.50
H2	1.07	1.27	1.47
L	2.00	2.30	2.60
L1	1.40	1.55	1.70
L4	0.25 BSC		
θ	0°	5°	9°

TO-220 package information

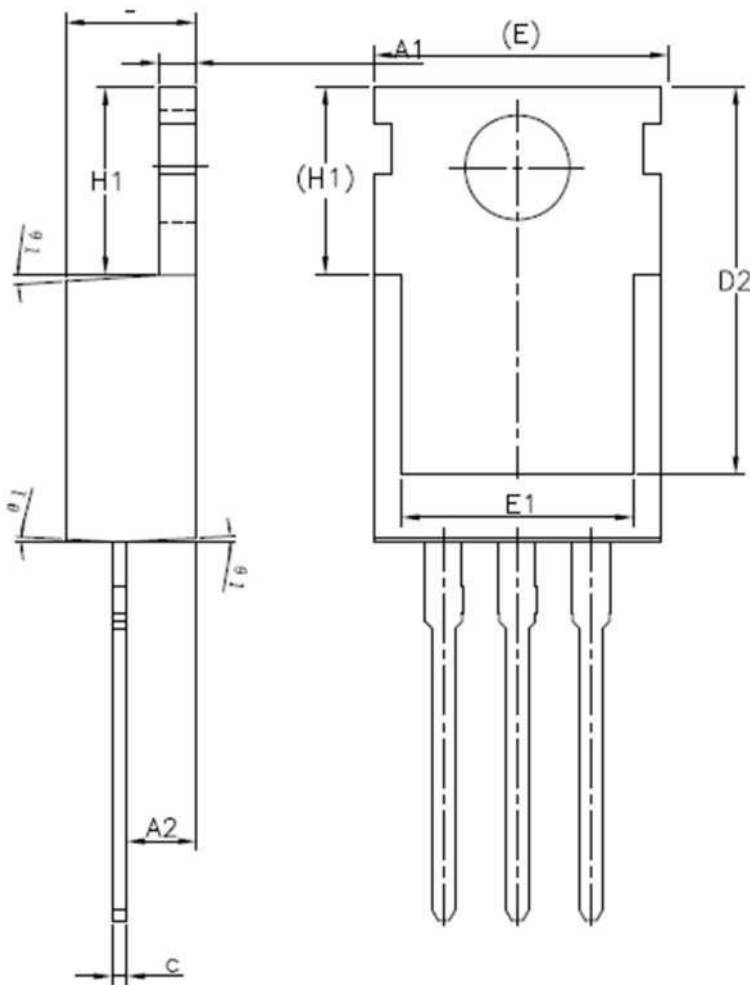

SYMBOL	MIN	NOM	MAX
A	4.40	4.50	4.60
A1	1.27	1.30	1.33
A2	2.30	2.40	2.50
b	0.70	-	0.90
b1	1.27	-	1.40
c	0.45	0.50	0.60
D	15.30	15.70	16.10
D1	9.10	9.20	9.30
D2	13.10	-	13.70
E	9.70	9.90	10.20
E1	7.80	8.00	8.20
e	2.54BSC		
e1	5.08BSC		
H1	6.30	6.50	6.70
L	12.78	13.08	13.38
L1	-	-	3.50
L2	4.60REF		
ϕP	3.55	3.60	3.65
Q	2.73	-	2.87
$\theta 1$	1°	3°	5°

