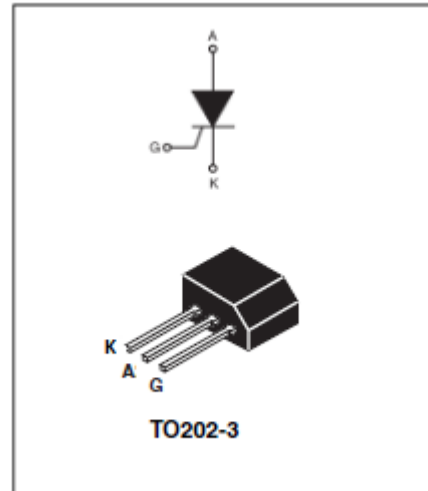

**YZPST-X0402 TO-202**
**DESCRIPTION:**

Thanks to highly sensitive triggering levels, the X0405 SCR series is suitable for all applications where the available gate current is limited, such as ground fault circuit interruptors, overvoltage crowbar protection in low power supplies, capacitive ignition circuits, ...

**MAIN FEATURES**

Symbol	Value	Unit
$I_{T(RMS)}$	4.0	A
$V_{DRM}$ $V_{RRM}$	600	V
$I_{GT}$	200	$\mu A$

**ABSOLUTE MAXIMUM RATINGS**

Parameter	Symbol	Value	Unit
Storage junction temperature range	$T_{stg}$	-40 ~150	$^{\circ}C$
Operating junction temperature range	$T_j$	-40~125	$^{\circ}C$
Repetitive peak off-state voltage ( $T = 25^{\circ}C$ )	$V_{DRM}$	600	V
Repetitive peak reverse voltage ( $T = 25^{\circ}C$ )	$V_{RRM}$	600	V
Non repetitive surge peak Off-state voltage	$V_{DSM}$	$V_{DRM} + 100$	V
Non repetitive peak reverse voltage	$V_{RSM}$	$V_{RRM} + 100$	V
RMS on-state current ( $T = 60^{\circ}C$ )	$I_{T(RMS)}$	4.0	A
Non repetitive surge peak on-state current (180° conduction angle, $F=50Hz$ )	$I_{TSM}$	30	A
Average on-state current (180° conduction angle)	$I_{T(AV)}$	2.5	A
$I^2t$ value for fusing ( $t_p=10ms$ )	$I^2t$	4.5	$A^2S$
Critical rate of rise of on-state current ( $I = 2 \times I_{GT}$ , $t_r \leq 100 ns$ )	$dI/dt$	50	$A/\mu S$
Peak gate current	$I_{GM}$	1.2	A
Average gate power dissipation	$P_{G(AV)}$	0.2	W

**ELECTRICAL CHARACTERISTICS (T=25°C unless otherwise specified)**

Symbol	Test Condition		Value	Unit
$I_{GT}$	$V = 12V$ $R = 140\Omega$	MAX.	200	$\mu A$
$V_{GT}$		MAX.	0.8	V
$V_{GD}$	$V_D = V_{DRM}$ $T_j = 125^\circ C$ $R = 1K\Omega$	MIN.	0.1	V
$I_L$	$I_G = 1.2I_{GT}$	MAX.	6	mA
$I_H$	$I_T = 50mA$	MAX.	5	mA
dV/dt	$V_D = 2/3V_{DRM}$ Gate Open $T_j = 125^\circ C$	MIN.	15	V/ $\mu s$

**STATIC CHARACTERISTICS**

Symbol	Parameter		Value(MAX.)	Unit
$V_{TM}$	$I_{TM} = 8.0A$ $t_p = 380\mu s$	$T_j = 25^\circ C$	1.8	V
$I_{DRM}$	$V_D = V_{DRM}$ $V_R = V_{RRM}$	$T_j = 25^\circ C$	5	$\mu A$
$I_{RRM}$		$T_j = 125^\circ C$	1	mA

**Thermal Resistances**

Symbol	Parameter	Value	Unit
Rth(j-a)	junction to ambient	60	$^\circ C/W$
Rth(j-t)	Junction to tab (DC)	10	

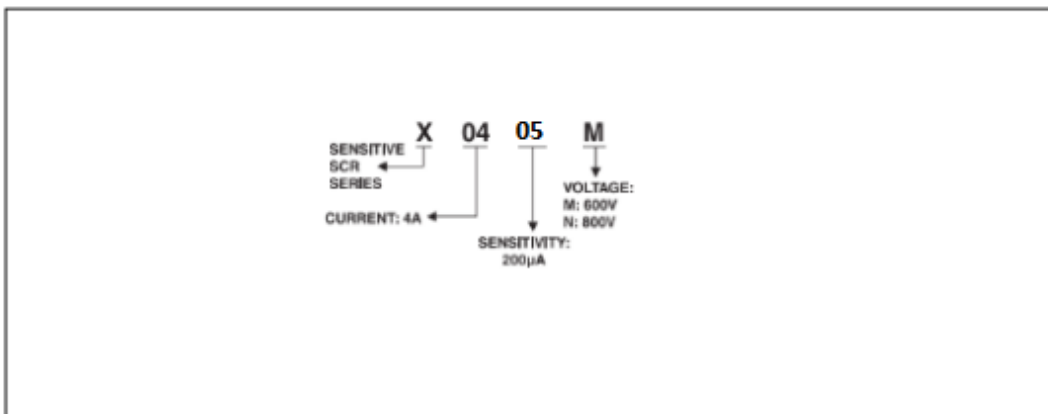
**Ordering information scheme**

**TO-202 Package Mechanical Data**

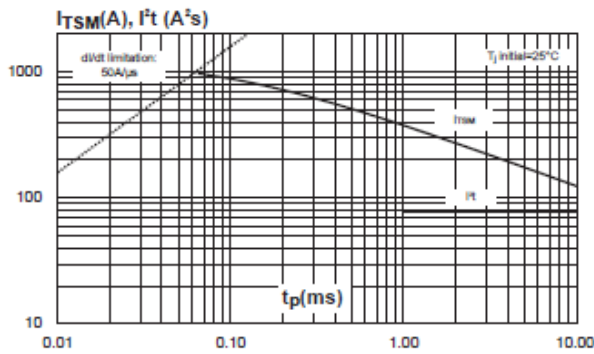
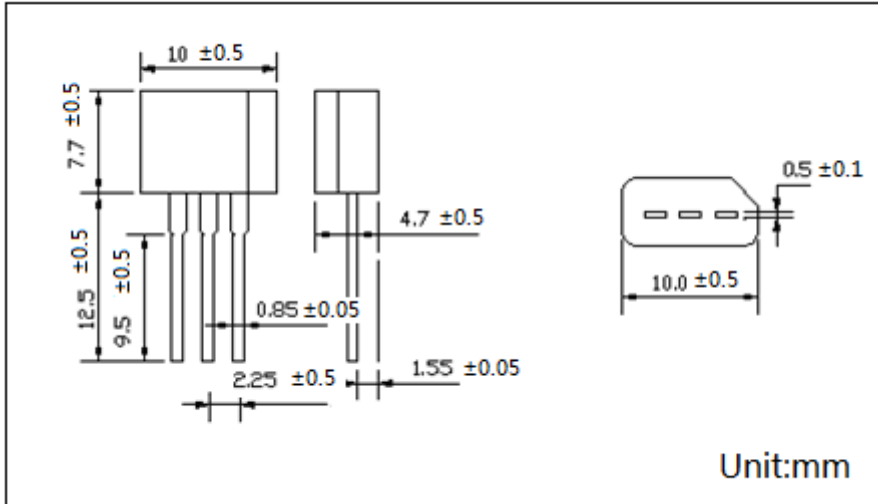

FIG.1 Maximum power dissipation versus Average on-state current

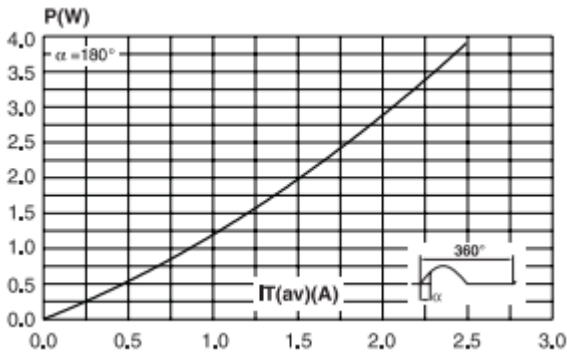

FIG.2: Average on-state current versus lead temperature

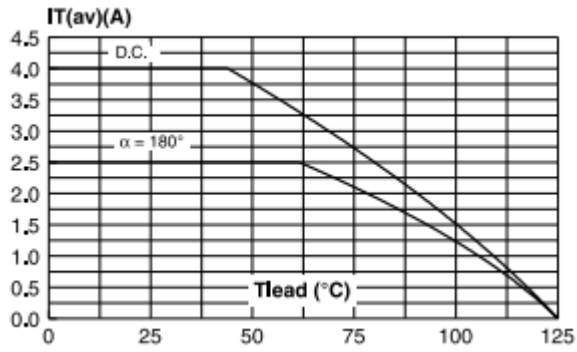

FIG.3: Surge peak on-state current versus number of cycles

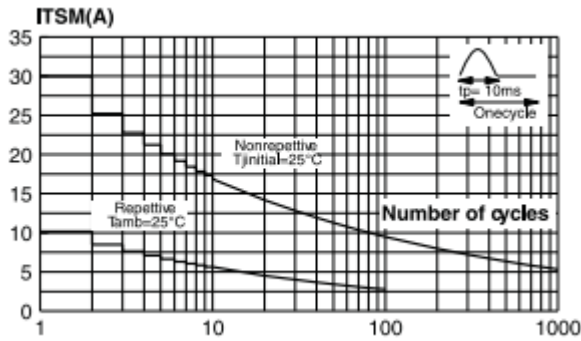

FIG.4: On-state characteristics (maximum values)

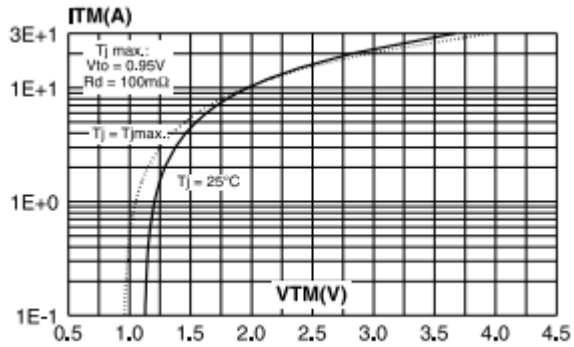

FIG.5: Non-repetitive surge peak on-state current for a sinusoidal pulse with width  $t_p < 10\text{ms}$ , and corresponding value of  $I^2 t$  ( $di/dt < 50\text{A}/\mu\text{s}$ )

FIG.6: Relative variations of gate trigger current holding current and latching current versus junction temperature

