

TECHNICAL DATA

SOLAR LIGHT TOWER



MPMC POWERTECH CORP.

SOLAR

HSL Series

HSL-1000B

Features

The solar light towers take the advantages of solar renewable energy and LED light systems on the road. Ideal for special events, construction sites, security and any other application where on-demand lighting is desired. This system provides cost-effective bright white LED lighting without all of the disadvantages inherent to diesel lighting systems – high operating costs (diesel fuel, maintenance, labor) as well as carbon emissions, noise, fumes and light pollution.

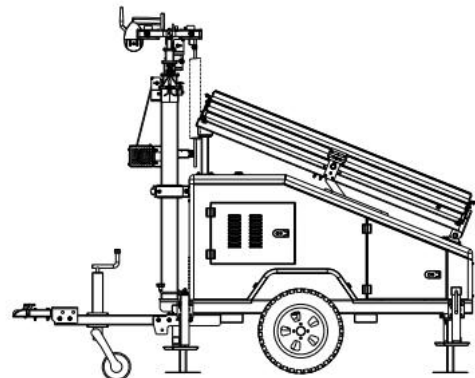
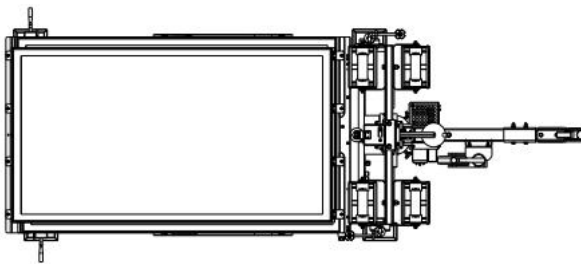
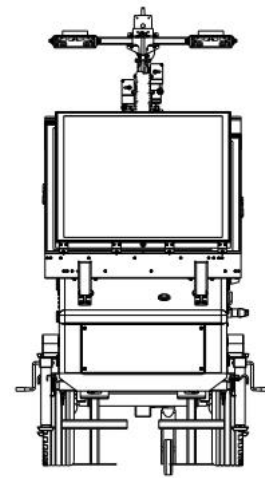
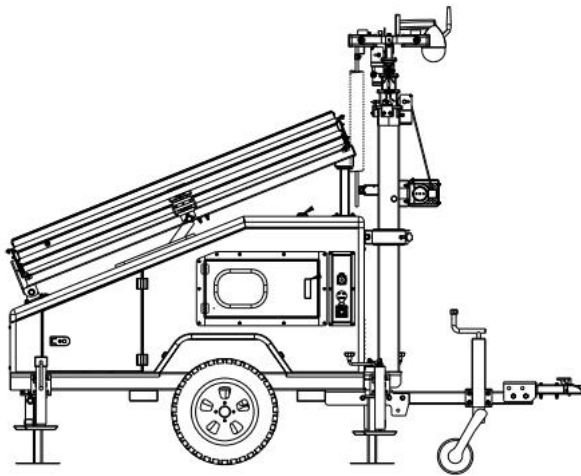

Dimension

Model	HSL-1000B
Expanding Dimensions	3400*2950*7500mm (LxWxH)
Loading Dimensions	2384*1250*2458mm (LxWxH)
Weight	795 kg
Loading Capacity in 40 HQ	5 units

General Specification

Rated voltage	DC24V
Rated Power (LED Lamp)	4 × 100W
Solar System Charge Time	4.5 Hours
Lighting Discharge Time	10 Hours
Standby Generator Charge Time	4.5 Hours

Solar Panel	
Maximum Power (Pmax)	335W
Maximum Power Voltage(Vmp)	37.6V
Maximum Power Current (Imp)	8.91A
Power Tolerance	0/+5 W
Dimension	1988*992*40mm(L*W*H)
Lifting angle	Fixed 30°
Extending type	Sliding
Extending area	5.2m ²
Quantity	3pcs
Battery Bank	
Type	LFP battery
Model	120AH 25.6V
Voltage	25.6V (One battery)
Maximum Charging Current	60A
Quantity	2pcs
LED Lamp	
Input Voltage	DC24V
LED Power	100W
Light Beam Angle	60°
LED Luminous Efficiency	160lm/w
Correlated Color Temperature	5000K
Protection Class	IP67
Quantity	4pcs
Solar Charging & Inverter	
Model	UP2000-HM6022
Nominal battery voltage	24VDC
Battery input voltage	21.6~32VDC
Max. battery charging current	60A
Inverter output	
Continuous output power	2000W
Max. surge power	4000W
Output voltage range	220VAC(-6%~+3%);230VAC(-10%~+3%)
Output frequency range	50/60Hz±0.2%
Output wave	Pure sine wave
Load power factor	0.2-1(Load power factor ≤ Continuous output power)
Distortion THD	THD≤3%(Resistive load)
80% rated output efficiency	92%
Max. rated output efficiency	91%

Max. output efficiency	93%
Utility charging	
Utility input voltage	176VAC~264VAC (Default);90VAC~280VAC (Programmable)
Utility input frequency	40~65Hz
Max. utility charge current	60A
Solar charging	
Max. PV open circuit voltage	450V(At minimum temperature);395V(25°C)
MPPT voltage range	80~350V
Max. PV input power	2500W
Max. PV charging power	1725W
Max. PV charging current	60A
Equalize charging voltage	29.2V(AGM default)
Boost charging voltage	28.8V(AGM default)
Float charging voltage	27.6V(AGM default)
Low voltage disconnect voltage	21.6V(AGM default)
Tracking efficiency	≥99.5%
Temperature compensate coefficient	-3mV/°C/2V (Default)
Operating temperature range	-20°C~50°C (When the working temperature reaches 30°C or above, the load power is reduced appropriately; full load working is not supported)
Enclosure	IP30
Quantity	1pcs
Trailer	
Model	B900 (On road)
Loading Capacity	900kg
Pulling Speed	≤60km/h
Tire and Rim Size	165R13
Drawing Bar	Ball Type
Stablished Supports	4 * Manual
Mast	
Mast Type	Electric
Maximum Lifting Heigh	7.5m
Mast Rotation	355°
Surface spraying	Galvanized
Option	
Backup Genset	Gas or Diesel , 2KW
Cameras	WIFI or 4G type

Contact Us

MPMC POWERTECH CORP.

Add:3rd Floor, Building 1, Powerlong City Plaza Pudong Shanghai China

Tel: +86 21 60970158 Fax: +86 21 60970155

E mail : sales@mpmc-china.com

Web site : www.mpmc-china.com



MPMC reserves the right to make changes in model, technical specification, color, configuration and accessories without prior notice.

Please contact the salesman before ordering.

DISTRIBUTED BY:

©2022 by MPMC, All right reserved.

