

# PBLR76FHS Series

## Frameless Brushless DC Motor

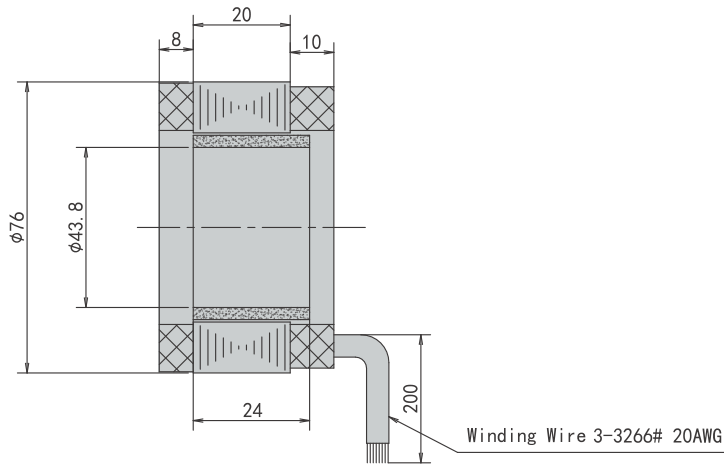

### General Specifications

Winding Type	Star/Delta
Dielectric Strength	600VAC/1S
Insulation Resistance	100M $\Omega$ ,500VDC
Ambient Temperature	-20°C ~ +50°C
Insulation Class	Class B

### Electrical Specifications

Motor Model	Unit	PBLR76FHS483030
Number of Phase		3
Number of Poles		16
Rated Voltage	VDC	48
Rated Speed	Rpm	3000
Rated Torque	N.m	1.0
Rated Power	W	314
Rated Current	A	8.7
Peak Current	A	26.1
Peak Torque	N.m	3.1
Rotor Inertia	kg.cm <sup>2</sup>	0.38
Torque Constant	N.m/A	0.1
Torque Constant	V/krpm	9.5
Line-Line Resistance	$\Omega$	0.8
Line-Line Inductance	mH	1.5
Length	mm	20
Weight	kg	0.9