

GLASSES

EQUIPMENT

医疗眼镜设备专业制造商

SPECIALIZED MANUFACTURER OF MEDICAL TECHNOLOGY
AND EYEGLASSES EQUIPMENT



上海拓扑威实业有限公司
Shanghai Top View Industrial Co.,Ltd

SHTOPVIEW

Tel: 0086-021-61178155

E-mail: info@shtopview.com

Web: www.shtopview.com

FDA Link:<http://www.accessdata.fda.gov/scripts/cdrh/cfdocs/cfRL/rl.cfm?rid=228201>





Fiscal Year 2023

FDA Registration Confirmation

Manufacturer: SHANGHAI TOP VIEW INDUSTRIAL CO.,LTD

Address: No.3388 GongHeXin Road,JingAn Shanghai , CN 200436

US Agent: Regrek LLC

Address: 19 Holly Cove Ln.,Dover, Delaware, 19901, UNITED STATES

The facility registration and device listing information:

Registration Number:3012707847 **Owner/Operator Number:** 10059986

Device Listing#: See annex

This attestation does not denote endorsement or approval of the attestation-holder's device or establishment by the U.S. Food and Drug Administration.

Pursuant to 21 CFR 807.39, "Registration of a device establishment or assignment of a registration number does not in any way denote approval of the establishment or its products. Any representation that creates an impression of official approval because of registration or possession of a registration number is misleading and constitutes misbranding." The U.S. Food and Drug Administration does not issue a attestation of registration, nor does the U.S. Food and Drug Administration recognize a attestation of registration.

Authorized Signature(s)

Signature:

Place: China/ Shanghai

Expiration Date: Dec. 31. 2023



企管理念: 品质诚信服务创新

企管精神: 传播成功理念, 推动企业规范管理

企管使命: 遵守品质管理满足客户需求

企管格言: 不断学习, 不断研究, 不断实践

企管价值观: 勤勤恳恳脚踏实地

Mangement idea:High quality,integrity,good service,innovation

Mangement spirit:Spread the idea of success,Promote the management of enterprises

Management mission:Compliance with quality management,meet the demand of customers

Management motto:Keep learning,keep studying, keep practicing

Management value:Painstakingly,dowm-to-earth



上海拓扑威实业有限公司

2008年在中国上海成立，是从事光学领域开发、生产、销售和服务的最大专业化公司之一。我们的主要产品包括眼科验光组合台、自动验光仪、查片仪、视力测试仪、裂隙灯、镜片磨边机等，我们还提供眼科检查医疗仪器，帮助患者改善“视力”状况和治疗眼部疾病。此外，我们还专门为眼镜店老板和光学中心提供眼镜装配工具和镜片切割机器。

我们拥有高科技的研发团队、先进的仪器和受过良好教育的员工团队。凭借多年的出口经验，我们的销售经理们了解各个国家的海关规则，同时精通设备的详细功能介绍。两者的完美结合，为客户节省了产品选择时间，推荐符合客户要求的机器型号，大大提升了采购体验，营造了良好的情绪价值，深受众多客户喜爱并不断地介绍其他有采购需求的客户。所有的订单流程都会被提前通知并与客户分享，我们承诺始终提供最好的服务，无论是在下单之前还是在交货之后。

不同的运输方式：卡车、铁路、空运和海运集装箱、使用 DHL、Fedex、UPS 和 TNT 的快速快递、Aramex、大多数快递订单货物在付款后 48 小时内快速发货是我们一直推崇并不断提升的亮点。

我们的绝大部分仪器都有 FDA、CE 和 ISO13485 认证。

上海拓扑威在产品研发上始终保持创新。

“细节创造品质”，SHTOPVIEW 在全球范围内寻找合作伙伴共同开拓新领域，有任何需要，不要犹豫，直接联系我们！

SHANGHAI TOP VIEW INDUSTRIAL CO.,LTD

is one of the biggest specialized companies engaged in development, production, sale and service in the optical field which was established in Shanghai,China in 2008.Our main products include ophthalmic combined tables and chair , auto refractometers, lens meters, view testers,slit lamp,lens edger and we also provide medical instruments for eye test,helping patients improve "vision sight" conditions and treating eye diseases. What's more ,we also specialize in providing glasses assembly tools and lens cutting machine for glasses shop owner and optics center.

We have a high-tech research team, advanced instruments and a well-educated staff team. With years of export experience, our sales managers know every countries' Customs rules,and know the detailed feature of the device ,the perfect combination of the two saves customers time in product selection and creates priceless value.All the order process will be well noticed and shared with customers in advance and we promise to give best service all the time ,befor the order and after the delivery .

Different methods of transporation : truck, rail, air and sea containers,fast express with DHL,Fedex ,UPS and TNT ,Aramex ,The highlighs of the fast express shipment for most of the products within 48 hours after payment .

Most of our instruments have FDA , CE and ISO13485 certification.

Shanghai Topview are always keeping innovation on the products research and develop.

"Details create quality".,SHTOPVIEW is looking for good partners global for cooperation to exploit new fields, contact us without hesitation.

MARKETkeen

Market acuity is prerequisite,
follows with technology and ability

Foresight is the only way to be knowledgeable, and paying close attention to the forefront of the industry is the prerequisite for improving professional standards. Topview always pays attention to industry trends, Further improve the self-research and development capabilities, to provide reliable high-end quality equipment for the glasses industry. A good reputation depends on excellent products and considerate after-sales service. Topview will continue to comprehensively improve the quality of employees and control the quality of the products strictly and strive to provide customers with better product solutions.

市场的敏锐度是先决条件，然后才是技术和能力

远见方能卓识，对于行业前沿的密切关注，是提升专业水准的前提。拓朴威时刻关注行业动向，进而提升自我研发能力，为眼镜行业提供可靠的高端优质设备。
良好的口碑取决于过硬的产品和贴心的售后服务。拓朴威将继续全面提升员工素质，严格把控每件产品的质量，竭力为客户提供更优质的产品方案。



PRODUCT CATALOG

CATALOG

- AUTO REFRACTO-KERATOMETER
- PHACOEMULSIFICATION SYSTEM
- HAND HELD VISION SCREENER
- OPERATION MICROSCOPE
- PHOROPTER
- STREAK RETINOSCOPE
- CHART SCREEN
- INDIRECT OPHTHALMOSCOPE
- LENSMETE
- OPTICAL COHERENCE TOMOGRAPHY
- OPHTHALMIC UNIT
- BIOMETER
- LED SLIT LAMP
- CORNEAL TOPOGRAPHY
- OPHTHALMIC ULTRASOUND SCANNER
- TONOMETER
- AUTOMATIC COMPUTER PERIMETE
- FUNDUS CAMERA
- AUTO LENS EDGER
- CERTIFICATIONS

Auto Refracto-Keratometer

自动验光仪

RK-800/RM-800



技术参数 FEATURES

Corneal Vertical Distance(VD): 0.00mm、12mm、13.75mm、15mm
SPH: -20.00 m ⁻¹ ~ +20.00 m ⁻¹ (VD=12mm, 0.01 m ⁻¹ 、0.06 m ⁻¹ 、0.12 m ⁻¹ 、0.25 m ⁻¹ unit) deep myopia measurement available
CYL: 0.00 m ⁻¹ ~ ±6.00 m ⁻¹ (0.25 m ⁻¹ unit)
Cylinder Form: -、+、±
Axis(AX): 1° ~ 180° (1° unit)
Pupil Distance(PD): 10mm ~ 85mm(0.1mm unit)
Radius of Corneal Curvature: 5.0 ~ 10.0mm (0.01mm unit)
Corneal Power: 33.00 m ⁻¹ ~ 67.00 m ⁻¹ (in case that the corneal equivalent refractive power is 1.3375)
Corneal Astigmatism: 0.00 m ⁻¹ ~ 15.00 m ⁻¹ (0.06 m ⁻¹ /0.12 m ⁻¹ /0.25 m ⁻¹ unit)
9" TFT touch screen
Printer: 57mm thermal printer
Measuring Light Energy: <30uW (prevent injury to eyes during measuring)
Measuring Time: <0.5s
Minimum 2.0mm pupil can be measured. The application of cloud and mist chart technology allows the patients' eyes to look at the internal targets in a natural and comfortable situation and make the measurement more accurate
Auto tracking, auto focusing and auto measuring of end of measurement (partial model)
Electrical Power: AC100 ~ 240V, 50/60HZ
Consumption: 60AV
N.W.: 24kgs
G.W.: 26.5kgs
Dimensions: L510mm×W328mm×H450mm

Auto Refracto-Keratometer

自动验光仪

ARK-7680



技术参数 FEATURES

Corneal Vertical Distance(VD): 0.00mm、12mm、13.75mm、15mm
SPH: -30.00 m ⁻¹ ~ +25.00 m ⁻¹ (VD=12mm, 0.01 m ⁻¹ 、0.06 m ⁻¹ 、0.12 m ⁻¹ 、0.25 m ⁻¹ unit), deep myopia measurement available for children, adolescents and adults
CYL: 0.00 m ⁻¹ ~ ±10.00 m ⁻¹ (0.25 m ⁻¹ , 0.25 m ⁻¹ unit) rical degree wide interval: 0.5D
Cylinder Form: -、+、±
Axis(AX): 1° ~ 180° (1° unit)
Pupil Distance(PD): 10mm ~ 85mm(0.1mm unit)
Radius of Corneal Curvature: 5.0 ~ 10.0mm (0.01mm unit)
Corneal Power: 33.00 m ⁻¹ ~ 67.00 m ⁻¹ (in case that the corneal equivalent refractive power is 1.3375)
Corneal Astigmatism: 0.00 m ⁻¹ ~ 15.00 m ⁻¹ (0.06 m ⁻¹ /0.12 m ⁻¹ /0.25m ⁻¹ unit)
8" TFT touch screen (angle adjustable)
Printer: 57mm thermal printer
Measuring Light Energy: < 30uW (prevent injury to eyes during measuring)
Measuring Time: <0.5s
Minimum 2.0mm pupil can be measured. The application of cloud and mist chart technology allows the patients' eyes to look at the in ternal targets in a natural and comfortable situation and make the measurement more accurate
Electrical Power: AC100 ~ 240V, 50/60Hz
Consumption: 60AV
N.W.: 17.25kg
G.W.: 22.5kg
Dimensions: L750mm×W400mm×H630mm

Full Autorefractometer Keratometer

全自动验光仪

FKR-710/FR-710



技术参数 FEATURES

Reference wavelength 850nm
Vertex distance (VD) : 0mm、12.0mm、13.75mm、15.00mm
Spherical refractive power: -20.00D~+20.00D
Cylindrical refractive power: 0D~6D
Direction of astigmatic axis: 0° ~180°
PD measurement : 45mm~85mm
Minimum pupil diameter : Φ2.0mm
Cornea curvature radius : 6.5mm~9.4mm
Direction of corneal astigmatic axis: 0° ~180°
Cornea diameter: 2.0mm~12.0mm
Monitor : 9.0" Touch LCD monitor
Auto cut thermal printer
Saving mode : 1/5/10/20/40 minutes automatic screen saver
Power supply : AC 230V 50Hz 75VA
Dimensions/Weight: 300(W)*450(D)*500-530(H)mm/20Kg
Spherical vertex power: -20.00D~+20.00D (-10.00D~+10.00D : ±0.25 D; > ±10D Tolerance: ±0.05D)
Cylindrical vertex power: 0 D to 6 D ±0.25 D
Cylinder axis for cylinder power: 0° to 180° ±5°
Cornea curvature radius : 6.5 mm to 9.4 mm ±0.05 mm
Direction of corneal astigmatic axis : 0° to 180°
For principal meridional differences in radii of curvature ≤ 0,3 mm : ±4°
For principal meridional differences in radii of curvature > 0,3 mm : ±2°

Full Autorefractometer Keratometer

全自动验光仪

ARK-1/AR-1



技术参数 FEATURES

Hartman Type Refractor
High-Definition Clear Retina Image with New Adapted High Speed Image Acquisition and Image Identification Flip Monitor
Auto Horizontal, Vertical and Back Force Motorized Focus
High Speed and Auto Cut Printer
VD Range: 0.0, 12.0, 13.75 and 15.0
Sphere Range: -20.00D~+20.00D (VD=12,0.01,0.06,0.12,0.25 Increments)
Cylinder Range: 0.00D~ +10.00D (0.06,0.12,0.25 Increments)
Axis: 1 Degree - 180 degree (1 degree Increments)
Cylinder Symbol: -, +, ± PD: 10~86mm Mini Pupil Size: 2.0mm
Average Measurement Time: < 0.5 second
Pupil Distance: 2.00-8.00mm
Max Brightness: < 30uw (safety Assure)
Curvature Radius: 5.0~ 10.0mm (0.01mm Increments)
Refractive Power: 33.00D~67.00D (When equivalent index of refraction of the cornea is 1.3375)
Cylindrical Power: 0.00D~15.00D (0.06D/0.12D/0.25D Increments)
Date Save: 10 Group Left/Right Eye
Axis: 1° ~180° Target: Auto Fog
Monitor: 8 Inch TFT Touch Screen (Flip)
Printer: 57mm Width Auto Cut
Power: AC 100~250V, 50/60Hz, Wide Voltage
Net Weigh: 22Kgs Gross Weight: 26 Kgs
Packing: (L) 600mm x (W) 400mm x (H) 600mm

Hand Held Vision Screener

视力筛查仪

SW-800



1. The portable auto refractometer can check the refractive error precisely for different groups of people using the ultrasonic ranging, cross line, flashing light and sound technology and then to find out the probably potential refractive problems.
2. Ideal for babies, seniors and patients with language barrier.

技术参数 FEATURES

Operation mode: Bino/Mono
Optometry: Automatic
DS: Range: -7.50D~+7.50D, Resolution: 0.25D/0.01D
Accuracy: ±0.50D
DC: Range: 0.00D~3.00D, Resolution: 0.25D/0.01D, Accuracy: ±0.50D
Axis: Range: 1° ~180° Axis: Range 1° ~180° Resolution: 1° Accuracy: ±5°
Pupil size: Range: 4.0mm~9.00mm
Resolution: 0.1mm Accuracy: ±0.1mm
Pupil distance: Range: 35mm~80mm
Resolution: 1mm, Accuracy: ±1mm
Gaze: 0° ~20°
Measuring distance: 1m ± 5cm
Time per measurement: ~1s
Fixation target: Light flash, attractive sound
Date interface: Wi-Fi, USB
Battery: Rechargeable lithium batteries, 6 hours of duration, Replaceable
Size: 180mmX130mmX110mm
Display: 5 inch touch screen
Weight: 0.8Kg
Optional accessories: Camera tripods, printer, etc

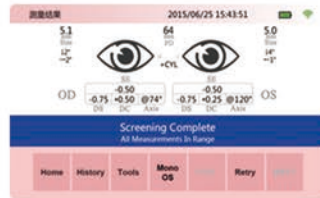

Hand Held Vision Screener

视力筛查仪

HAR-680



技术参数 FEATURES

Sphere range: - 10.0D ~ +70.0D, step 0.25D
Cylinder range: -5.0D ~+5.0D, step 0.25D
Axis of astigmatism range: 1° -180° , 1°
Data acquisition time: <1s/ eye
Iris imaging Connections: Yes
Connections:
USB, Wi-Fi, Bluetooth; easy data transfer to pc or printer
Accessories: Bluetooth printer(optional)
Dimensions: 203 mm x 170 mm x 50 mm

The easyRef detects the following vision disorders:

Myopia (nearsightedness)	Hyperopia (farsightedness)
Astigmatism (blurred vision)	Anisometropia (unequal refractive power)

APPLICATIONS



For Screening Events

With the easyRef you can screen 100 patients within 20 minutes. The compact and light-weighted design makes it highly comfortable for portable use.



For Primary Care

The easyRef is a cost-effective . essential vision screening tool for general practitioners (GPs) and ophthalmologists. It can be used for home visits or in a health screening van.

easyRef

EASY REFRACTION SCREENING SOLUTION



The easyRef™ is an innovative wavefront refractometer that precisely measures refractive errors of patients from 6 months old through adults within just seconds.

The device is designed and engineered to be handy and user-friendly with one-button operation. With the short working distance, the device is extremely easy-to-focus.

Anyone

It refracts children, adults, with or without contact lenses.

Anytime

The test of both eyes is complete in a few seconds, makes it easy to get refraction screening done.

Anywhere

No dark room required. The easyRef works under normal lighting conditions.

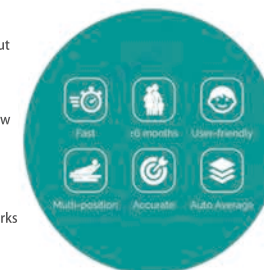

For Clinics and Optical Shop

With the easyRef you can reach more patients outside of your practice or use it in some promotion events such as an optical fair or free vision screening marketing campaign.



VT-5A



技术参数 FEATURES

Sphere powers range:
+16.75 to - 19.00D, with minimum reading 0.25D or 0.12D
(When+0.12D auxiliary lens or optional±0.12D lens is in use)

Cylinder powers range:
0 to-6.00D, with minimum reading 0.25D or 0.12D (when
auxiliary lens is in use)

0 to-8.00D (when-2.00D auxiliary lens is in use)

Astigmatic axis scale: 0° to180° , each step is 5°

VT-5E



Cross cylinder: ±0.25D, reversal type (synchronized with
astigmatic axis), also can select ±0.50D

Rotary prism: 0 to 20 ΔD, each step is 1 ΔD

Interpupillary adjustment: 50mm to 80mm, each step is
1mm (right and left synchronized)

Forehead rest adjustable: 16mm backward and forward

Convergence: The optical axes of the lenses are aligned
at a distance of 400mm from the vertexes of the corneas
(2mm each for right and left inward)

VT-5B



Interpupillary distance enabling convergence=57mm
to 80mm

Corneal distance device: 2mm forward and 5mm
backward from standard plane with scale

Effective visual range: 19mm

Weight: 5kgs

Size: 323mm×315mm×85mm

Phoropter

综合测光仪

VT-5C



KF-ZD6000



技术参数 FEATURES

Sphere: 0.00~-19.00 Diopters, step: 0.25, 0.5, 1,3
0.00~+16.75 Diopters, step: 0.25, 0.5, 1,3

Cylinder:0.00~±8.75 Diopters, step: 0.25, 0.5, 1,3

Cylinder Axis: 0° to 180° , step: 1° ,5°

Prism form: Base up, base down, base in, base out

Near distance: Mechanical converging with an optical axis at
30 to 40 in front of eye

Binocular balance: Rotary prism, polarizing filter and R & G filter

Cross cylinder: ±0.25D

PD: 50 to 80mm in 1 and 0.5mm step

Retinoscope: +2.00D or +1.50D both sides

Corneal alignment: 12 to 20mm by 2mm step

Field of view 35°

Power source: AC 110-120V/220-240V.50/50Hz,90VA

Dimension: 350 (W) x300 (H) x80 (D) mm

Net weight: 4kg

Power supply: AC 110-240V 50/50Hz

Horsepower: 60w



VC-1



技术参数 FEATURES	
Power:	AC100V~240V/50HZ/60HZ
Standard Power:	60W Standby Power: 2W
Maximum Screen Resolution :	1680×1050@60HZ
Distance:	0.282mm Screen Ratio: 16:9
Screen Type:	TFT Screen Size: 21.5"
Visible Size:	476mm×310mm Visual Angle: H:170/V:160
Color:	16.7M Max.Brightness: 300cd/m ²
Maximum Contrast :	2000:1
Signal Response Time:	5ms Weight: 3.8Kg(5.0Kg)
Out Size:	504×310×45mm
Working Distance:	1m~6.5m (Adjustable)
Record of vision test result:	Max.remote-controlling distance>8m
Emote-controlling distance:	Imperial fraction,or decimal

K-185



技术参数 FEATURES	
Electrical source:	AC100V~240V/50HZ/60HZ
Rated power:	45W Standby power: 2W
Screen resolution ratio:	1440×900@60HZ
Dot pitch:	0.284mm Screen ratio: TFT
Screen type:	16:9 Screen size: 19"
Visible angle:	408.24mm×222.15mm Visible size: 16.7M
Max.Brightness:	300cd/m ² Color: H:170/V:160
Max.contrast ratio:	2000:1
Signal response time:	5ms Weight: 5.0Kg(6.2Kg)
Overall size(mm):	460×355×200mm
Effective distance:	2m~5m (Adjustable)
Record of vision test result:	Max.remote-controlling distance>8m
Emote-controlling distance:	Imperial fraction,or decimal

VC-235



技术参数 FEATURES	
Electrical source:	AC100V~240V/50HZ/60HZ
Rated power:	60W Standby power: 2W
Screen resolution ratio:	1680×1050@60HZ
Dot pitch:	0.282mm Screen ratio: TFT
Screen type:	16:9 Screen size: 23.5"
Visible angle:	473.76mm×296.1mm Visible size: 16.7M
Color:	H:170/V:160 Max.Brightness: 300cd/m ²
Max.contrast ratio:	2000:1
Signal response time:	5ms Weight: 5.5Kg(6.8Kg)
Overall size(mm):	532×411×200mm
Effective distance:	2m~8m (Adjustable)
Record of vision test result:	Max.remote-controlling distance>8m
Emote-controlling distance:	Imperial fraction,or decimal

Chart screen

液晶视力表

VC-13

China combined optometry with 19 inch LCD eye chart portable equipment VC-13



技术参数 FEATURES	
Standard power consumption:	about 60W
Maximum contrast	2000
Maximum contrast	2000: 1
Standby power consumption:	less than 2W
Signal corresponding time:	5ms
The maximum resolution of the screen is	1680*1050*60HZ
Dimensions:	560 * 190 * 470 MM
Screen pitch:	0.282mm
Machine weight:	6.7Kg
Screen type:	TFT
Use distance:	1M~6.5M adjustable
Screen ratio:	16:9
Visual recording method:	decimal, imperial score recording

Screen size:	19"
Remote control distance:	The maximum remote control distance is not less than 8m
Visual size:	530mm X 335mm
Shield:	horizontal / vertical / single character
Color:	16.7M
Viewing angle:	H:170/V:160
With trail lens box:	NO
Standard test pattern:	Letter eye chart / children's eye chart / red and green blind test table / E word eye chart / C word eye chart / WORTH four point object / digital eye chart / cross chart / contrast sensitivity test table / CLCR red Green optotype / cellular optotype / Markov rod visual standard / loose disc optotype, etc.

Auto Lensmeter

自动查片仪

LM-900



技术参数 FEATURES

Sphere: 0m ⁻¹ to±25m ⁻¹
Cylinder: 0m ⁻¹ to±10.00m ⁻¹
Add: 0m ⁻¹ to±10.00m ⁻¹
Astigmatism: 0° to 180°
Prism basal Angle measurement range: 0° to 360°
Prism: Horizontal 10cm/m, Vertical 15cm/m
The accuracy of measurement
Dioptric: (0.01/0.12/0.25) m ⁻¹
Prism: (0.01/0.12/0.25) cm/m
Mode of measurement
Cylinder: +, ±, -
Prism: X-Y, P-B
Speed of measurement: 0.2 second
Diameter of measurable lens: 18 to 110mm
Other parameters
Display: 1024*600 TFT and touch screen
Printer: Thermal printer
Size: 255 (W) x 212 (L) x 473 (H) mm
Weight: About 5.1kg
Power supply: AC100~240V 50/60Hz
Power: 25VA

Manual Lensmeter

手动查片仪

GJD-7



技术参数 FEATURES

1. Measuring range:3mmHg-70mmHg
2. Precision: ±1.5mmHg(3mmHgSIOP≤25mmHg); ±2.5mmHg(25mmHg<IOP≤70mmHg);
3. Measurement Mode: Both vertical and horizontal measurement
4. Output: Wireless Infrared Thermal Printer
5. Easy to Use
6. Small Size, Easy to Carry
7. No need Anesthesia, No Discomfort ableness
1. Rango de medición: 3 mmHg-70 mmHg
2. Precisión: ± 1,5 mmHg (3 mmHg<IOP≤25 mmHg); ± 2,5 mmHg (25 mmHg <IOP≤ 70 mmHg);
3. Modo de medición: medición vertical y horizontal
4. Output: Impresora térmica infrarroja inalámbrica
5. Fácil de usar
6. Tamaño pequeño, fácil de transportar
7. Sin necesidad de anestesia, sin molestias.
1. Campo di misura: 3mmHg-70mmHg
2. Precisione: ± 1.5mmHg(3 mmHg<IOP≤25 mmHg); ± 2,5 mmHg (25 mmHg <IOP≤ 70 mmHg);
3. Modalità di misurazione: misurazione sia verticale che orizzontale
4. Uscita: stampante termica a infrarossi wireless
5. Facile da usare
6. Piccole dimensioni, facile da trasportare
7. Nessuna necessità di anestesia, nessun disagio

Auto Lensmeter

自动查片仪

LM-260



技术参数 FEATURES

Sphere Lens: 0to±35D (Increments 0.01D/0.06D/0.12D/0.25D)
Range: Increments:
< 0D, ≥ -5D > 0D, ≤ +5D ±0.06
< -5D, ≥ -10D > +5D, ≤ +10D ±0.09
< -10D, ≥ -15D > +10D, ≤ +15D ±0.12
< -15D, ≥ -20D > +15D, ≤ +20D ±0.18
< -20D, ≥ -25D > +20D, ≤ +25D ±0.25
Cylinder Lens: 0to±10D (Increments 0.01D/0.06D/0.12D/0.25D)
Axis: 0° to 180° (Increments 1°)
ADD: 0 to 10D (Increments 0.01D/0.06D/0.12D/0.25D)
Prism: 0 to 15Δ (0.01Δ)
Prism Range: Increments:
>0Δ, ≤5Δ 0.1Δ
>5Δ, ≤15Δ 0.2Δ
Cylinder Mode: +, +/-, -
Prim Mode: cartesian coordinatesH: I,O,V;U,D P-B:polar coordinates
mm: X and Y in mm
Increments: 0.01D/0.06D/0.12D/0.25D

PD Measurement

Measure single vision lens,bifocal lens,trifocal lens and progressive lens,etc
UV/Blue Light Transmissivity Detection
CL Lens Accessable
Reflect Ratio: >10% Reflect Ratio while Diopter over +/-10D>20%
Contact lens: 0 to ± 25D, BC 6.00 to 9.00
Monitor: 7.0 Inch HD Touch Screen
Menu: humanized Design and Easy Operation
Lens Diameter Capacity: 20mm-100mm
Voltage: AC100(±10%) -240 (±10%) V 50/60Hz 40VA
Power: 40W
Weight: 6.8kgs
Machine Size: 550mm*350mm*350mm (L*W*H)
Storage Condition
a.Temperature: 5-40°C(In use) -20-60°C(Storage/Transportation)
b.Humidity: 30-85% 10-95%(Storage/Transportation)
c.Air Pressure: 700-1060hpa
d.Altitud: up to 2000m
e.Others: No Harmful Dust or Smog

Auto Lensmeter

自动查片仪

L890

- 7.0-inch HD touch color display
- Streamlined, faddish, abundant and atmospheric design
- Green LED light source, ABBE compensation no require
- High grade ABS material case, zero failure rate quality standard
- Rapidly and automatically determine and measure the progressive lens in high precision
- Upgraded Hartmann intelligent measurement technology, faster, more accurate and more stable

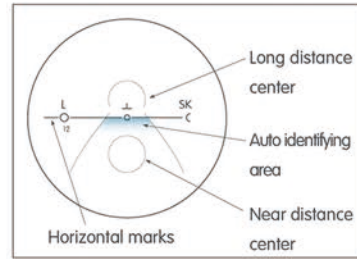

Progressive lens measurement

Automatically determine the lens type single vision lens or progressive lens, quickly locate long distance center and near distance center of progressive lens, accurate measurement of ADD values.

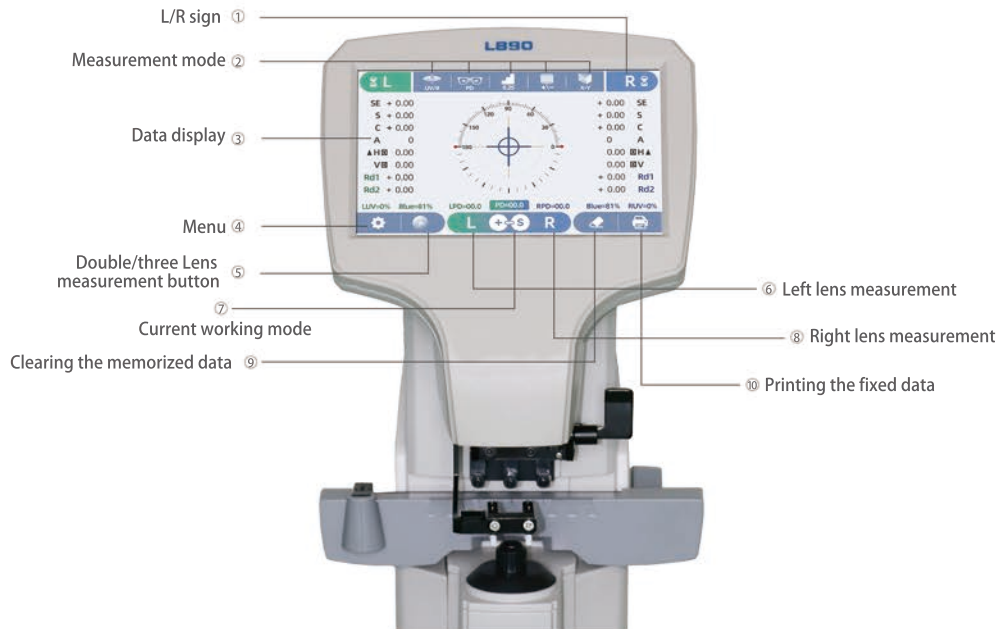
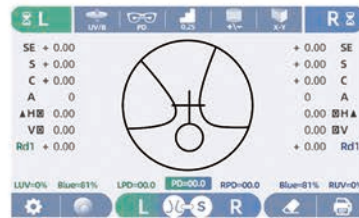

Hartmann sensor with 145 multiple measurement points

Hartmann 145 sense points, equipped with high speed and high efficiency CCD camera, fast and accurate measurement, ABBE compensation no need.

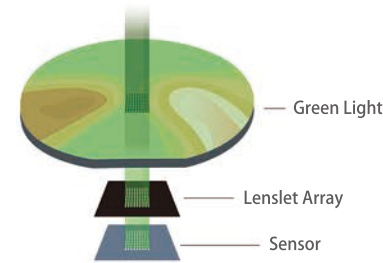

技术参数 FEATURES

Sphere Lens: 0to±25D (0.01D/0.06D/0.12D/0.25D steps)

Range:	Increments:	
< 0D, ≥ -5D	> 0D, ≤ +5D	±0.06
< -5D, ≥ -10D	> +5D, ≤ +10D	±0.09
< -10D, ≥ -15D	> +10D, ≤ +15D	±0.12
< -15D, ≥ -20D	> +15D, ≤ +20D	±0.18
< -20D, ≥ -25D	> +20D, ≤ +25D	±0.25

Cylinder Lens: 0to±10D (0.01D/0.06D/0.12D/0.25D steps)

Axis: 0° to 180° (1° steps)

ADD: 0 to 10D (0.01D/0.06D/0.12D/0.25D steps)

Prism: 0 to 15Δ (0.01Δ)

Measuring Range:	Accuracy:
> 0Δ, ≤ 5Δ	0.1Δ
> 5Δ, ≤ 15Δ	0.2Δ

Cylinder Mode: +, +/-, -

Prim Mode: X-Y: Cartesian Coordinates H:I,O,V:U,D

P-B: Polar Coordinates

mm: mm expression

Reading resolving power: 0.01D/0.06D/0.12D/0.25D

PD Measurement

Measure single vision lens, bifocal lens, trifocal lens and progressive lens, etc

Contact lens measure

Uv transmissivity test

Measurable transmissivity: >10%; >20% at ±10D and over

Contact lenses: 0 to ±25D, BC 6.00 to 9.00

Display: 7.0 Inch HD touch color display

Menu: readable diagram, easy operation

Lens Diameter: 20mm-100mm

Power source: AC100(±10%) -240 (±10%) V 50/60Hz 40VA

Power consumption: 40W

Weight: 6.8kgs

Dimensions (packing): 565mm*350mm*355mm (W*D*H)

Environmental condition

a. Temperature: 5-40°C (In use) -20-60°C (Storage/Transportation)

b. Humidity: 30-85% 10-95% (Storage/Transportation)

c. Air Pressure: 700-1060hpa

d. Altitud: up to 2000m

e. Others: No Harmful Dust or Smoke

3D Full automatic edging machine

3D全自动免模机

SJG-1000AK



技术参数 FEATURES

AUTO LENS EDGER
Dimension: 680mm×460mm×450mm
Weight: 60kg
Voltage: AC 220V, 50Hz or 110V, 60Hz
Size range: Ø22-80mm
Clamping pressure: Third gear adjustable
Power: 550W
Wheel diameter: Ø90mm
Touch screen: 8inch capacitive screen



技术参数 FEATURES

AUTO LENS SACNNER
Dimension: 230mm×370mm×200mm
Weight: 5kg
Voltage: AC 220V, 50Hz or 110V, 60Hz
Screen tilt angle: 20°-100°
Touch screen: 7inch capacitive screen
Power: 60W
Quantity of connecting with the main machine: 1 unit

Patternless Lens Edger

免模板镜片磨边机

PLE-6800



技术参数 FEATURES

HIGH EFFICIENCY AND HIGH STABILITY
European Diamond Wheels Group: Perfect edging, high fineness, durable for long use.
Adaptive Clamp Chuck: Because of the large difference in thickness, the high curved lenses are easy to cause displacement due to axis twisting during processing. The design of adaptive clamp chuck ensures that the clamping force is balanced during processing to minimize axis twisting and any potential damages to lenses.
EDGER TECHNICAL INDEXES
Graphic editable and scalable functions
Bidirectional water jet and built-in lighting in processing cabin
Max. number of stored images: 400pcs
Adjustable beveling position
Lens Material: Plastic, Polycarbonate, High index plastic, Glass, Trivex
Diameter of diamond wheels group: 100mm
Edging Mode: Beveling (normal/auto/manual mode), Flat edging, Polishing
Max. Cutting Diameter: 80mm
Mini. Beveling Size: 22mmMini. Flat Edging Size: 20mm
Max. Frame Center Distance: 100mm
Display: 10.4-inch color TFT LCD touch screen with angle adjustable
Input Voltage: AC220V, 50Hz/AC110V, 60Hz
Output Voltage: DC 5V3A, DC 24V5.8A
Power Consumption: 1000w
Net Weight: 48kg
Dimensions: 636mm x 452mm x 591 mm
SCANNER/BLOCKER TECHNICAL INDEXES
Imaging System: Dual center optical imaging system
Scanning and Positioning System: Scanning imaging, precise center positioning
Scanning Time:<3s
Scanning Precision: 0.1mm
Display: 8-inch color TFT LCD touch screen
Power Supply: AC100-240V 50/60Hz
Net Weight: 9kg
Dimensions: 470mm x 230mm x 320mm

Auto Lens Edger

镜片磨边机

WZ-720P



技术参数 FEATURES
Rinding disc clamp force: 0.5-0.75Mpa
Lens material: CR , PC , GL
Size: 550×470×410mm
Voltage: AC 220V, 50Hz or 110V, 60Hz
Grinding Diameter: 22-80mm
Weight: 48kg
Electric power consumption: ≤ 500AV
Wheel diameter: Φ100*Φ17mm
Temperature: 5°C-40°C
Power: 380W
Grinding wheel group capulity: 60-100mm
Noise: ≤65db + 125%

Auto Lens Edger

镜片磨边机

WZ-720



技术参数 FEATURES
Rinding disc clamp force: 0.5-0.75Mpa
Lens material: CR , PC , GL
Size: 550×470×410mm
Voltage: AC 220V, 50Hz or 110V, 60Hz
Grinding Diameter: 22-80mm
Weight: 50kg
Electric power consumption: ≤ 500W
Wheel diameter: Φ100mm
Temperature: 5°C-40°C
Power: 380W
Grinding wheel group capulity: 60-100mm
Noise: ≤65db + 125%

Patternless Lens Edger

免模板镜片磨边机

FE-600



技术参数 FEATURES
Specifications
Automatic Initialization
Lens front and rear face tracing: 3D
Function:
1. Roughing Glass Edging
2. All Plastic Edging (CR39, High Index, Polycarbonate)
4. Bevel/Rimless Finishing Edging
5. Bevel/Rimless Polishing Edging
Automatic Clamping Pressure
Edging pressure controlled according to lens material
Graphics storage
Convenient Water Connection

Lens Edging Diameter:
1. ≤ to 80mm
2. Rimless: 17.75mm
3. Bevel: 19.50mm
Drain Size: Ø100mm
Water Supply Pressure: from 4 to 7 bars
Network Connection
Dimensions:
1. Width: 650mm
2. Depth: 450mm
3. Height (visor close): 470mm
Weight: 59kg
Power Supply: 220V/50HZ 110V/60HZ
Power Consumption: 800 W

Ophthalmic Unit

TR-700A

检眼组合工作台



Mechanical Parameters

Phoropter swing arm: Swing angle (up and down) $\pm 30^\circ$
 Rotary arm: rotation angle $0^\circ - 300^\circ$
 Up and down moving range: 900mm~1500mm
 Max load: 30Kgs

Auto keratometer arm: Swing angle (up and down) $\pm 40^\circ$
 The first rotary arm rotates at an Angle 360°
 The second rotary arm rotates at an Angle $0^\circ - 300^\circ$.
 The tray can be 360° rotation
 Up and down moving range: 780mm~1380mm
 Max load: 30Kgs

Projector arm: Angle of rotation for rotary arm 360° .
 The tray can be 360° rotation
 Up and down moving range: 1030mm~1530mm
 Max load: 10Kgs

Slip lamp arm: Table size: 350mm \times 200mm \times 25mm
 (Can be customized, maximum size is
 700mm \times 400mm \times 40mm)
 Max load: 50Kgs

Table movement range:
 within a semicircle with a radius of 824mm
 Height adjustment range: 716mm ~ 1016mm
 Table rotational angle:
 The first rotary arm rotates at an Angle $0^\circ - 180^\circ$
 The second rotary arm rotates at an Angle $0^\circ - 360^\circ$
 The third rotary arm rotates at an Angle $0^\circ - 180^\circ$
 Table-board rotational angle: 360°

Seat parameter: Lifting range 568~708mm
 Headrest adjusting range 250mm
 Seat rotation angle $0^\circ \sim 270^\circ$
 Footrest height from ground: minimum 88mm
 Backrest adjusting angle $80^\circ - 180^\circ$
 Max. load: 150Kgs

技术参数 FEATURES

In voltage: 100-200V AC 50Hz/60Hz
200-240 AC 50Hz/60Hz
Output Voltage: 100-120V 50Hz/60Hz
200-240V 50Hz/60Hz
2.5V 3.5V 4.5V 5.5V 6.5V 7.5V 12V AC
Charging voltage: 5V DC
Engine power: 28V 1.5A DC
Light: 5/16W 24V DC
Fuse: 5A 130/250V AC
No load power: 1W
Pressure test: 2KV
Working mode: S1
Man wire: 10A 120V/250V
Working temperature: $-10^\circ\text{C} \sim +40^\circ\text{C}$
Relative humidity: less than 90%
Installation Dimension
Figure size: 1884mm \times 1316mm \times 1663mm (No contain table top or lighting)
Weight: 295kgs



Ophthalmic Unit

TR-102A

检眼组合工作台

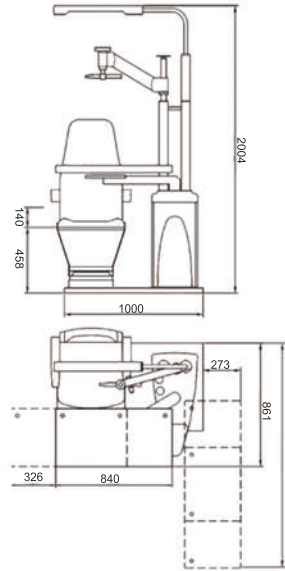

技术参数 FEATURES

Up/Down angle of swim arm: $\pm 30^\circ$
Table size: 840mm \times 405mm 670mm \times 405mm
Table rotational angle: 90°
Table aliding movement range: 330mm
Angle of rotation for chair: $\pm 60^\circ$
Chair height adjustment range: 460-600mm
Loding for chair: 150kgs
Lifting height for pillow: ≤ 150 mm
Backrest obliquity: $90^\circ \sim 135^\circ$
Input voltage: 110V/220V AC 50Hz~60Hz
Engine power: 55W 220V AC
Light: 16W 110V/220V AC
Fuse: 5A 250V AC
No load power: 1W
Pressure test: 2KV
Main wire: 10A 250V
Working mode: S1
Working temperature: $-10^\circ\text{C} \sim +40^\circ\text{C}$
Relative humidity: less than 90%
Figure size: 1560mm \times 1000mm \times 2000mm
Weight: 175kgs

Ophthalmic Unit

TR-900

检眼组合工作台

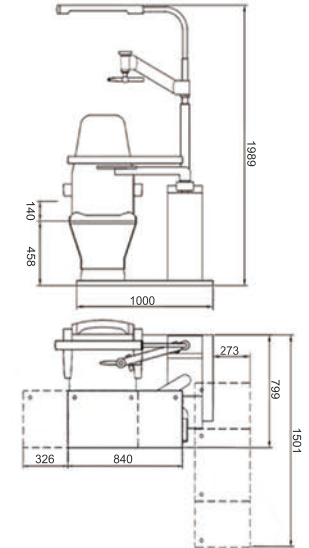

技术参数 FEATURES

Up/Down angle of swim arm: $\pm 30^\circ$
Table size: 840mm \times 405mm 670mm \times 405mm
Table rotational angle: 90°
Table aliding movement range: 330mm
Angle of rotation for chair: $\pm 60^\circ$
Chair height adjustment range: 460-600mm
Loding for chair: 150kgs
Lifting height for pillow: ≤ 150 mm
Backrest obliquity: $90^\circ \sim 135^\circ$
Input voltage: 110V/220V AC 50Hz~60Hz
Engine power: 55W 220V AC
Light: 16W 110V/220V AC
Fuse: 5A 250V AC
No load power: 1W
Pressure test: 2KV
Main wire: 10A 250V
Working mode: S1
Working temperature: $-10^\circ\text{C} \sim +40^\circ\text{C}$
Relative humidity: less than 90%
Figure size: 1500mm \times 1000mm \times 1990mm
Weight: 175kgs

LED Slit Lamp

裂隙灯

LS-4



技术参数 FEATURES

Microscope Type: Parallel type, Galilean system
Magnification Changer: Revolving drum
Eyepiece Magnification: 12.5X
Magnification: 6X,10X,16x,25x,40x
Diopter: -7D~+7D
Pupil Range: 52mm~82mm
Visual Field Diameter: 6X:33mm;10X:22mm;16X:14mm; 25X:8.5mm;40X:5.5mm
Illumination Type: Haag Streit Type
Slit image width: 0mm~14mm continuously adjustable
Slit image length: 1mm~14mm continuously adjustable
Slit image angel: 0~180° continuously adjustable
Illumination tilting: 5°、10°、15°、20°
Slit aperture size: φ0.2、φ1、φ3、φ5、φ10、φ14(mm)
Filter: Heat absorption, Grey, Redfree(green), Cobalt blue
Light Source: Warm LED
Max Illumination Intensity: 60000Lux

LED Slit Lamp

裂隙灯

LS-5



技术参数 FEATURES

Microscope Type: Parallel type, Galilean system
Magnification Changer: Revolving drum
Eyepiece Magnification: 12.5X
Magnification: 6X,10X,16x,25x,40x
Diopter: -7D~+7D
Pupil Range: 52mm~82mm
Visual Field Diameter: 6X:33mm;10X:22mm;16X:14mm; 25X:8.5mm;40X:5.5mm
Illumination Type: Haag Streit Type
Slit image width: 0mm~14mm continuously adjustable
Slit image length: 1mm~14mm continuously adjustable
Slit aperture size: φ0.2、φ1、φ3、φ5、φ10、φ14(mm)
Filter: Heat absorption, Grey, Redfree(green), Cobalt blue
Light Source: Warm LED
Background illumination: Co-axial
Software: Adaptive parameters
Camera is optional

LED Slit Lamp

裂隙灯

BL-66B



技术参数 FEATURES

Microscope Type: Converging stereoscope microscope	Pupillary Adjustment: 50mm ~ 82mm
Magnification Selection: Two Steps Magnifications	Slit Height: 1 ~ 8mm Continuous
Eyepiece: 10X	Slit Angel: 0~180° adjustable
Magnification Ratio(Field of View): 10x(18mm), 16x(14.5mm)	Diameter of Light Spot: p9mm、p8mm、φ5mm、φ3mm、 q2mm、φ1mm、p0.2mm
Diopter Adjustment: +5D	Filter: Heat Absorption, Grey, Red-Free, Cobalt Blue
Base Side Shift: 110mm	Illumination Bulb: 12v 50w halogen lamp
Depth Shift: 90mm Height Shift: 30mm	Input Voltage: 110V/220V AC Frequency: 50/60Hz
Chin rest Height Shift: 80mm Fixation Target: Red LED	Power Consumption: 68VA Gross Weight: 18kg
Slit Width: 0 ~ 9mm Continuous (at 9mm, slit becomes a circle)	Dimension: 690mm (L) x 440mm (W) x 420mm (H)

Portable Slit Lamp

便携式裂隙灯

LS-1A/1B



技术参数 FEATURES

Slit type: Rotating slit wheel selection slit lamp
Optical type: Binocular hand held Biomicroscope slit lamp
Eyepiece: Converging binocular at 13°
Magnification: 10X/10X、16X lever change
Work distance: 80mm Pupil distance: 45mm~78mm
Diopter compensation: -8D~+8D
Resolution of visual center:
16X:N A=0.0448, 10X:N A=0.0402
Nominal diameter of visual field:
10X:15mm/10X:15mm 16X:10mm
Illumination Slit width:
0.1mm, 0.2mm, 0.8mm, φ1mm, φ5mm, φ12mm
Slit length: 12mm Slit angle: Horizontal ±60°
Filters: Neutral density Red-free, Cobalt blue
Lighting bulb: High brightness white LED
Brightness: ≥30000Lux
LED work voltage: DC 3.0V (1.5V AA battery X 2)
Direct power supply: Direct charger
Battery (Optional): Wireless working mode AA Dry battery, or AA rechargeable battery
Size: 169.5mm×109.5mm×228.5mm
Weight: ≤900g (with battery)

Portable Slit Lamp

便携式裂隙灯

BL-5000



技术参数 FEATURES

Microscope Type: Converging microscope
Objective Magnifications: Two steps magnifications
Magnification: 10X、16X
Diopter Adjustment: ±7D
Pupil Distance: 60mm
Working Distance: 52mm~82mm
Slit Width: 0~10mm continuously adjustable
Diameter of Light Spot: 1mm、3mm、5mm、10mm
Filter: Heat absorption, Grey, red-free, Cobalt Blue
Slit Angle: ±30°
Light Source: LED
Maximal Illumination: ≥30000LX
Power: 7.4V 2200mAh Li Battery, Rechargeable
Working Time: 2.5 hours for common use
Packing Volume: 216mm×100mm×225mm
Net Weight: 900g

Digital Slit Lamp with Dry Eye Module

干眼数码裂隙灯

LS-5C



技术参数 FEATURES

T M H: Auto/Manual
NIBUT: Auto
Static lipid layer analysis: Manual
Dynamic lipid layer analysis: Manual simple video comarison
Ocular Redness Analysis: Auto/Manual
Gland Opening: Manual
Meibomian glands: Manual
Corneal Staining: Manual
Eye position recognition: Auto
Questionnaire: 3 types
Optical effect: Excellent optical effect
Collector: Built-in professional level medical collector has 20 million pixels
Spot Size: φ0.2, φ1, φ3, φ5, φ10, φ14,
Color filter: Heat absorption, Grey filter, Red-free, Cobalt blue filter
Light source: Warm LED
Background Light: Coaxial background light

All-Round

Support 7 dry eye detection functions
Provide a reliable basis for clinical diagnosis

AI

Using AI algorithm to analyze images and recordings Like,high precision good repeatability

Detailed

The picture restores the real Report,clear and detailed Show the examination results

Non-Invasive

Non-Invasive inspection way Safer operation Patient comfort and easy cooperation

8 Minutes

8 minutes can be quick Complete the full set of dry eye examination

Ophthalmic Ultrasound Scanner

眼科超声

SK-3000



技术参数 FEATURES

B-Scan	Frequency: 10MHz	Scan Mode: Mechanical Setor Scanning	Frequency: 10MHz	Measurement Range: 0-60mm	
Gray Levels: 256	Adjustable Gain: 20-105db	Depth: ≥ 60mm	Angle of Exploration: 53°	Accuracy: ≤ 0.04mm	
Time Gain Control (TGC): 0-30db	Image Freezing: 20 pcs	Resolution: Axial ≤ 0.2 mm, lateral: ≤ 0.4mm	Mode: B, B+A	Default Eye Mode: 6 Different Modes and 3 Customized Modes	
Resolution: Axial ≤ 0.1 mm, lateral: ≤ 0.2 mm	Depth: 220mm	Frequency: 20MHz	Angle of Exploration: 53°	IOL Calculation: 6 different methods and comparing calculation	
A-Scan				Calculation Method: Standard Deviation Pachymeter	
				Frequency: 10MHz	Accuracy: ≤ 0.01mm
				Depth: 0.3-1.5mm	Output Mode: Video Print
				Other Parameter	
				Computer: Built-in System, 12.1-inch Touch Screen Display	
				Picture Processing: Brightness, Contrast, Image Playback, Pseudo-color, Image measurement, Image Remark	
				Printer: Sony Duplicator, Computer with Graphic Workstation	

Ophthalmic Ultrasound Scanner

眼科超声

RetiWave1000



技术参数 FEATURES

- All touch screen, easy to operate
- Large color display with backlight and brightness control
- Portable design and light weight Built-in thermal printer
- Either combination unit (A+P) or single (A or P)
- Pachymeter
- Probe: 20MHz, angle of 45 degrees makes easier operation
- Precision: 5 μm
- Measure range: 300 μm~1500 μm
- Each group is the average of 10 measures
- Output: LCD display and thermal print
- Display: Large color liquid-crystal screen
- SINGLE mode and MAP mode
- A-Scan
- Probe: 10MHz, with LED
- Depth: 15mm-35mm
- Precision: ±0.05mm
- Examining Method: immersion and contact
- Eye Mode: SRK-II, SRK-T, HOFFER-Q, HOLLADAY, BINKHORST-II, HAIGIS
- Curve Freeze: control by foot switch auto freeze and manual freeze.
- Output: A scan table and calculation and thermal print
- Store: 10 cases(eyes), 5 reading each case
- Manual and auto modes

技术参数 FEATURES

- A-Scan biometry
- Probe frequency: 10MHZ
- Measuring mode: contact
- Measuring range: over 5mm~40mm
- Measuring type: ≤ ±0.05mm
- Image freezing: auto,auto+preservable,manual
- Intraocular lens Implantation(IOL)formula: SEK-T,SRK-II, HOLLADAY,BINKHORST-II,HOFFER-Q,HAIGIS
- Gain: 20~110dB
- Time gain adjustment: 0~30dB
- B-Scan Patterns
- Image freezing: auto,auto+preservable,manual
- Probe frequency: 10MHZ
- Probing depth: ≥50mm
- Axial Resolution: ≤0.2mm
- Lateral resolution: ≤0.3mm
- Gain adjustment: 20~110dB
- Time gain adjustment: 0~30dB
- Operation mode: eyecup,gel,aqueous capsule
- Post-processing measuring tools:
area,length,mark and annotation
- Size: 340mm(L)×320mm(W)×115mm(H)
- Weight: 10Kg Power supply: 100~240V 50/60V

Ophthalmic Ultrasound Scanner

眼科超声

SW-1000



Ophthalmic Ultrasound Scanner

眼科超声

ODU-5



技术参数 FEATURES

- Adopt ARM9 Embedded Control Systems, FPGA signal processing system and elaborate selected ultrasonic hardware system
- 10.4 inch high resolution LCD screen,Menu operation
- Language: Chinese/English
- Double probe sockets:
- A mode probe: 10MHz, imported probe with fixation light
- B mode probe: 10MHz, imported transducer
- Display mode: B, B/B, 4B, B/A, A
- Gains range: 0~120dB
- Dynamic range: 30-100dB, visual and adjustable
- Gray: 256
- Intelligent TGC adjustment: 8 segments
- Build-in D disk: 4GB, save mass data, images, reports, etc
- Report function:
print screen, IOL report, case report with picture, etc
- A scan
- Resolution: 0.01mm Gain adjustable: 0-120dB
- Measurement range: 12-43mm(1640m/s)
- Accuracy: ±0.02mm
- Measuring parameter: ACD, LENS, body Length, axial length
- Eye mode: normal/aphakia/dense cataract/PMMA, Acrylic & Silicon for Pseudo Phakic eyes

- Measuring Mode: Contact and Immersion, automatic and manual
- Measurement methods: A single-point measurement (under A mode) ; five-point measurement (under A mode)
- Calculation: std. deviation, average, automatical measuring 8 groups and average, accompany waveform, results correctable
- IOL Formula: SRK-II, SRK-T, BINKHORST,HOLLADAY, HOFFER-Q, HAIGIS
- B scan:
- Scan mode: High accuracy stepping motor drive sector scan.
- Scan Angle: 53° Display Depth: 0~56mm
- Gray: 256 Frame frequency: 10frames/s
- depth seletion: 8 Frame correlation: 4
- Edge enhancement: 4 Compression Curve: 4
- Post-processing: 8 100 frames permanent image storage
- Cine loop: 256 frames,can measure the playback image
- Disk management
- General Measurement: multi-electronic-rule to measure distance, circumference, area(trace method, ellipse method),volume (ellipse method), angle , histogram, profile , stenosis and curvature etc
- Specification
- Power supply: 100-240V~ 1.2-0.6A Frequency: 50-60Hz
- Adapter output: DC 12.8V 3.0A

Automatic Computer Perimeter

视野计

BIO-1000



技术参数 FEATURES

Inspection range: 90°
Inspection distance: 30CM
Background brightness: white31.5asb
Visual target brightness: GoldmannIII
Visual target interval time: 200ms
Visual target interval time: Standard or adjustment according to patient reflection
Detection strategy: 10-2, 24-2, 30-2, 60-4, C-40, C-64, C-76, FF-81, FF-120, FF-135, nasal side
Special detection strategy: Esterman monocular, Esterman binocular, user-customized test, driver monocular or binocular detection, upper 36° detection, blind spot detection.
Pupil size test: Automatic
Fixation monitoring: Blind spot monitoring, eye position video, motoring
Environment light detection: Automatic
Analysis software: Reliability analysis, single vision report, triple visionreport, GPA half vision analysis,GPA glaucoma developing analysis, VFI vision index analysis
Operation system: Win7 above
Size: 412mm(length)*497mm(width)*513mm(height)
Weight: 17kg
Power: 100-240V, Hz: 50/60Hz

BIO-1000

The Bio-1000 automated perimeter absorbs the advantage of international advanced perimetry devices. It comprises the highly intergrated computer, optics. machinery and electronics systems. Incorporated with the advanced configuration, comprehensive software inspection categories, it provide international standard 6 analysis report of glaucoma, fundus disease, visual pathway injury and neurological diseases.

Technical Features

Comprehensive real-time monitoring, heiji-krakau physiological blind spot monitoring, gaze tracking/head position tracking, automatic measurement of pupil diameter, reduce the impact of pupil effect on visual field detection.
 Personalized design, accurate clinical analysis, accurate and rapid examination strategy.
 A variety of classic test procedures, including international standard six report analysis.

Note: with development of technology, specifications and design are subject to change without notice.

Projection Perimeter

视野计

BIO-1100



技术参数 FEATURES

Testing scope: 90°
Testing distance: 30CM
Background light: white31.5asb, yellow315asb
Visual target: 0.08asb---10000asb(0-51DB)
Target size: Goldmann I, II, III, IV, V
Visual target stimulation time: 200ms
Visual target interval time: Standard and custom
Threshold policy: C-40, C-64, C-76, FF-81, FF-120, FF-135.....
Special detection strategy: Esterman monocular, Esterman binocular, upper36° screening, blind point testing
Yellow-blue testing: Standard 440nm blue V visual target +315asb OG530 yellow background brightness
Visual target: Red, Blue
Dynamic policy: Standard dynamic blind, dynamic, dark spot dynamic, straight line dynamic
Custom policy: Static custom dynamic custom
Pupil size measurement: Auto
Fixation monitoring: Physiological blind spot monitoring, eye position monitoring, eye position moving alarm, eye tracking curve
Environment light testing: Auto

Technical Features

- Rigorous implementation of Goldman international standard.
- Halogen projection system: Stimulation light source is from wide band visible spectrum, fully meet colored cone cell stimulation.
- Accurate and elaborate database of normal population of all agegroups, recognition of more subtle early visual field defects.
- GHT glaucoma semi vision analysis, make glaucoma diagnosis easier.
- GPA glaucoma progression analysis upgrade, slight glaucoma development is obvious.
- Standard SWAP blue-yellow visual field examination, sensitive to earlier visual field defects.
- Scientific and intelligent interactive inspection strategy, 30° range visual field defects.
- Simple one-stop modular software design, equipment operation learning only 2 minutes.

Analysis software: Reliability analysis, single report, triple, GHT glaucoma semi vision report, GPA glaucoma developing analysis, VFI analysis, Blue-yellow analysis
System: Win 7 above
Size: 412mm(length)*497mm(width)*513mm(height)
Weight: 17kg
Power: 100-240V, Hz: 50-60Hz

Phaco Emulsifier

眼科超声乳化

MD-480A



Description

All parts of the system are fully controlled and monitored by Microprocessor Technology:

- Smoothly and efficiently controlling the emulsifier process with digital frequency tracing technology of handpiece
- Easy operation and user-friendly interface with large touch screen TFT and functional menu
- Up to 10 sets of parameters preset meets differt requirements and simplifies the surgery operation
- Auto test checks tubing and handpiece problems(e.g.:block or leakage)

- The peristaltic pump gives complete control of aspiration flow rate as well as freedom from anterior chamber shallowing. This way can give stronger sution when working in I/A
- Built-in vitrectomy and cautery
- Intelligent voice reminder



技术参数 FEATURES

- Ultrasonic Emulsification (U/S)
- Frequency: 40kHz
- Functional mode: Continuance, Pulse, Linear, Burst
- Continuance: Emulsifying Power range:0~100%
- Pulse: Frequency range 1~99Hz
- Linear: Emulsifying Power linerally controlled by the Footswitch, varies between 0~100%
- Burst-Stopping Time: 1.5~0s
- Burst-working Time: 5-100ms
- Maximum Vacuum: 500mmHg
- Maximum Flux Rate: 40ml/min
- Irrigation/Aspiration(I/A)
- Flux Rate: 0~40ml/min
- Reflux Rete: 20ml/min
- Max Vacuum: 0~500mmHg
- Vitrectomy(VIT)
- Cutting POver Source: Air pump
- Cutting Frequency: 20~600/min;Single cut mode
- Maximum Vacuum: 500mmHg (200Ω)
- Maximum Flux Rate: 40ml/min
- Cautery
- Maximum Power: 10W±20% (200Ω)
- TyPe: Bipolar
- Power Preset between: 0~100%



TRISONIC Phacoemulsification System

MTP 白内障超声乳化系统

The TRISONIC Surgical System:

- Advanced Cataract Removal
- State of the Art Performance
- Lightweight and Portable
- 24 Customizable User Programs
- Four US Modes
Continuous, Pulse, Burst and Micro
- Large 12.1" Touchscreen
- All Titanium Handpiece
- Integrated Coagulation and Vitrectomy
- Programmable Multi Function Footpedal
- Easy to Inset, Reusable Tubing Cartridge
- Rugged Travel Case Included
- Integrated IV Pole Optional

Standard Accessories:

- U/S Handpiece
- Tubing Cartridge
- Footpedal
- Travel Case

Optional Accessories:

- Phaco Tips
- I/A Handpiece
- Aspiration Tips
- Irrigation Sleeve
- Test Chamber
- Vitrector
- Coagulation Forceps/Cord



Technical Parameters

技术参数 FEATURES

FLUID DELIVERY	Graviyt Fed
	US (ULTRASONIC)
HANDPIECE TYPE:	All Titanium, Lightweight, balanced handpiece
OPERATING FREQUENCY:	40KHz
AVAILABLE VACUUM LEVEL:	From 0 to 500 mmHg
SURGON MODE (LINEAR POWER):	Allows linear control of US power by depressing footpedal
MULTI MODULATION:	Allows for rapid transition for aspiration and phaco settings
US BURST MODE:	Allows for surgeon control of pulse width in phaco power
MICRO PHACO:	Allows for surgeon control of both the on-time and off-time of the phaco pulse
PRIME/TUNE MODE:	Automatically primes system and tunes ultrasonic handpiece
	IA (IRRIGATION/ASPIRATION)
ASPIRATION PUMP:	Peristaltic, low pulsation
AVAILABLE VACUUM LEVEL:	From 0 to 500 mmHg
AVAILABLE ASPIRATION FLOW RATE:	From 0 to 50 cc/min
SURGEON MODE (LINEAR ASPIRATION):	Linear aspiration (vacuum and/or flow rate) from zero to preset
HANDPIECE TYPE:	Coaxial IA, user's choice
	VIT (VITRECTOMY)
HANDPIECE TYPE:	Pneumatically powered guillotine cutter
CUTTING MODE:	Guillotine action
AVAILABLE CUT RATE:	From 60 to 700 cuts per minute
ACTUATION DEVICE:	Internal air compressor
OPERATING PRESSURE:	20PSI
AVAILABLE VACUUM RANGE:	0 to 500 mmHg
AVAILABLE ASPIRATION FLOW RATE:	0 to 50 cc/min
SURGEON MODE (LINEAR ASPIRATION):	Linear aspiration (vacuum and/or flow rate) from zero to preset
	COAG (COAGULATION)
TYPE:	Bipolar generator
OPERATING FREQUENCY:	315kHz
NOMINAL POWER:	5.5 Watts (250 Ohm load)
AVAILABLE COAG POWER:	5 to 100%
SURGEON MODE (LINEAR POWER):	Allows linear control of the Coag power by depressing footpedal
	DIMENSIONS
H/W/D/WT:	6.5in (16.5cm) / 14.5in (36.8cm) / 13.5in (34.3cm) / 21lbs (9.55kg)



MODEL 2000 Phacoemulsification System

MTP 白内障超声乳化系统

- Advanced Cataract Removal
- State-of-the-Art Performance
- Could Phaco Capability
- Easy-to-Use Precise Controls
- FDA Approved
- ISO Certified Quality
- Affordable Price



Standard Accessories:

- U/S Handpiece
- Footpedal
- Tubing Kit

Optional Accessories:

- Phaco Tips
- I/A Handpiece
- Aspiration Tips
- Irrigation Sleeve
- Test Chamber
- Vitrector



Technical Parameters

Mode	Specification
CAUTERY	CAUTERY POWER: 0 to 100%, 1 MHz, 10W into 150 ohms
I/A	ASPIRATION RATE:0 to 50 cc/MIN I/A VACUUM:0 to 650 mmHg
U/S	U/S POWER:0 to 100%, 40kHz ASPIRATIONRATE:0 to 50 cc/MIN U/S VACUUM: 0to 650 mmHg
U/S PULSE	U/S POWER:0 to 100%, 40kHz ASPIRATIONRATE:0 to 50 cc/MIN U/S VACUUM: 0 to 650 mmHg Pulse Rates: <ul style="list-style-type: none"> • LO 4.5 PPS • MED 6.5 PPS • HI 10 PPS • XTR 15 PPS
U/S COLD	U/S POWER:0 to 100%, 40kHz ASPIRATIONRATE:0 to 50 cc/MIN U/S VACUUM: 0 to 650 mmHg Pulse Widths: <ul style="list-style-type: none"> • LO 20 PPS • MED 40 PPS • HI 90 PPS • XTR 200 PPS
VITRECTOMY	U/S POWER:0 to 100%, 40kHz ASPIRATIONRATE:0 to 50 cc/MIN U/S VACUUM: 0to 650 mmHg

技术参数 FEATURES

- All Titanium Phaco Handpiece
- Continuous Autotuning
- Three (3) Phaco Modes
- Low-Pulsation Periataltic Pump
- Separate U/S Vacuum Controls
- Independent Vacuum & Flow Controls
- Multiple Audible Status Tones
- Reflux On-Demand
- Pneumatic Vitrectomy
- Bipolar Cautery
- Reusable Accessories
- Small and Compact
- No Complicated Menu System
- No Programming Required
- Superior Components
- Multi-Function, Linear-Control Footpedal
- U/S Timer with Reset

General

Specification

Dimensions

Height: 14.6 cm (5.7 in)
width: 41.2 cm (16.2 in)
depth: 33.0 cm (13.0 in)

Weight

weight: 7.4 kg (16.4 lbs)

Electrical

100 to 240 VAC, 50 to 60 Hz

- FDA approved
- ISO 13485 Quality Certification
- Satisfies IEC 60601-1 Specification
- Made in the USA

Operation Microscope

YZ-20T9

手术显微镜



技术参数 FEATURES

Eye-piece Magnification: 12.5×/18B
Objective Lens: f=200mm Working Distance: 190mm
Magnification for Main Microscope: 4×、6×、10×、16×、25×
Magnification for Assistant Microscope: 6×、10×、16×
Diameter of Field: Φ58mm、Φ38mm、Φ23mm、 Φ14mm、Φ9mm
Adjustable Diopter: ±5D
Adjustable Range for Pupil Distance: 50mm~75mm
Maximal Resolution: 119LP/mm
Focus for Assistant Microscope: ≥30mm
Illumination Source: 12V/100W,cold reflection halogen bulb for medical use
Illumination Type: 6° +0° coaxial illumination of cold light source and 20° oblique illumination (It can be used as slit illumination) Slit Width is adjustable
Coaxial Illumination: ≥50000lx
Oblique Illumination: ≥45000lx
Reaching Radius of Arm: 1240mm
Adjustable Vertical Range: 850mm~1350mm
Fine Focusing Speed and Range: ≤2mm/s, 50mm
Speed for X/Y and Range: ≤2mm/s, 50mm×50mm
Power Supply: AC220V±22V/50Hz±1Hz, AC110V±11V /60Hz±1Hz
Power : 330VA
Fuse: AC250V T4.0A(51S-040H)、AC125V T8.0A(51S-080L)
Electrical Safety Standard: Executive standard: GB9706.1-2007、Class I
Packing Volume: 0.756m³, 5cartons
Total Gross Weight: 215kg

Characteristics:

- Advanced apochromatic technology and unique optical balanced technology effectively improves the binocular visual fusions, strengthens in third dimension and reduces surgeon's tiredness during operations.
- Fine focusing knob is under the bottom of assistant binocular. The observation of the assistant's microscope can be finely focused independently of the main microscope to avoid different from surgeons.
- 20° oblique illumination can also be used as slit illumination. Slit width is continuously adjustable.
- For ophthalmic use.



Operation Microscope

YZ-20T4

手术显微镜



技术参数 FEATURES

Eye-piece Magnification: 12.5×/18B
Magnification for Main Microscope: f200: 4×、6×、10×、16×、25× f250: 3.2×、5×、8×、12.8×、20× f300: 2.7×、4.2×、6.7×、11×、17×
Working Distance: f200:190mm f250:240mm f300:290mm
Magnification for Assistant Microscope: f200: 6×、10×、16× f250: 5×、8×、12.8× f300: 4.2×、6.7×、11×
Adjustable Diopter: ±7D
Adjustable Range for Pupil Distance: 50mm~75mm
Maximal Resolution: 112LP/mm
Illumination Source: 12V/100W,cold reflection halogen bulb for medical use
Illumination Type: 6° +0° coaxial illumination of cold

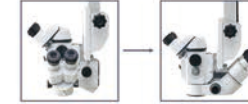

• Assistant microscope can be rotated to opponent microscope.



• Internal beam splitter can be connected with teaching tube and CCD system.



• Equipped with three different objective lenses (f200/f250/f300) and applicable in ophthalmic surgery, orthopedic surgery and hand surgery.

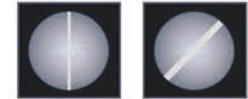

• Oblique illumination can also be used as slit illumination and slit width is adjustable.

light source and 25° oblique illumination (It can be used as slit illumination) Slit Width is adjustable and its angle is 360° rotation
Coaxial Illumination: ≥50000lx
Oblique Illumination: ≥45000lx
Reaching Radius of Arm: 1040mm
Adjustable Vertical Range: 850mm~1350mm
Fine Focusing Speed and Range: ≤2mm/s, 50mm
Speed for X/Y and Range: ≤2mm/s, 50mm×50mm
Power Supply: AC220V±22V/50Hz±1Hz, AC110V±11V /60Hz±1Hz
Power : 330VA
Fuse: AC250V T4.0A(51S-040H)、AC125V T8.0A(51S-080L)
Electrical Safety Standard: Executive standard: GB9706.1-2007、type I
Packing Volume: 0.727m³, 5cartons
Total Gross Weight: 210kg

Operation Microscope

SOM-2000D

手术显微镜



- Germany Schott optics ensures the surgeon bright, balanced and fine observation.
- Apochromatic technology used in the optical design , ensures coaxial light focus and provides clearer field of view.
- Lock device under the microscope arm ensures the safe distance and prevents accidents from happening.
- Independent electrical control box with the function of automatic.

技术参数 FEATURES

Eyepiece Magnifications: 12.5×
Objective Lens: f=200mm
Working Distance: 170mm
Magnification for Main Microscope: 4.6×~27× motorized and manual control continuous magnification
Magnification for Assistant Microscope: 6×、10×、16×
Diameter of Field: Φ46mm~Φ8.5mm
Adjustable Diopter: ±5D
Adjustable Range for Pupil Distance: 55mm~75mm (main microscope is 45mm~80mm)
Focus for Assistant Microscope: ≥30mm
Illumination Source: 12V/100W,cold reflection halogen lamp for medical use
Illumination Type: 6° +0° coaxial illumination of cold light source,26° oblique illumination
Coaxial Illumination: ≥60000lx,1~9level,panel operated
Oblique Illumination: ≥60000lx,1~9level,panel operated
Reaching Radius of Arm: 1230mm
Adjustable Vertical Range: 880mm~1420mm
Fine Focusing Speed and Range: ≤2mm/s, 50mm
Speed for X/Y and Range: ≤2mm/s, 50mm×50mm
Power Supply: AC110V/220V±10%, 50Hz/60Hz
Power Consumption: 170VA
Fuse: T4.0AL 250V, T8.0AL 125V
Packing Volume: 0.756m³, 5cartons
Total Gross Weight: 215kg



Operation Microscope

YZ-20P5

手术显微镜



- Column stand can be reflitted to holding stand. It can also be customized according to various operation requirements.

技术参数 FEATURES

Eyepiece Magnifications: 12.5×
Objective Lens: f=200mm
Working Distance: 190mm
Magnification for Main Microscope: 5.3×、8×、12×
Diameter of Field: Φ37mm、Φ8.5mm、Φ16.7mm
Adjustable Diopter: ±6D
Adjustable Range for Pupil Distance: 50mm~80mm
Illumination Source: 12V/100W, medical cold reflection halogen lamp
Illumination Type:
6° +0° Coaxial of cold light source illumination
Coaxial Illumination: ≥30000lx
Reaching Radius of Arm: 870mm
Adjustable Vertical Range: 30mm
Power Supply: AC110V/220V±10%, 50Hz/60Hz
Power Consumption: 120VA
Fuse: T1.25AL 250V, T2.5AL 125V
Packing Volume: 0.2m³, 1cartons
Total Gross Weight: 41kg

Streak Retinoscope

YZ-24

检眼镜



技术参数 FEATURES

- The well positioned filament can be rotated for 360° and upward and downward moved Brightness of the streak can be adjusted...
 - Quickly and precisely measure the astigmatism axis.
 - The light can be converged, radiated and paralleled.
 - Automatic turning off effectively protects the bulb.
 - Two-steps adjustable brightness for bulb: S (Bright), W (Dark)
- Working Distance: 1m
 Streak width: 3mm-20mm
 Rotatable Angle: 360°
 Illumination Source: 3V/2.1W, Halogen Bulb
 Power Supply: AC110V/220V±10%, 50Hz/60HZ

YZ-24B

技术参数 FEATURES

- The filament can be 360° rotated and be adjusted upward and downward.
- Quickly and precisely measure the astigmatism axis.
- The light can be converged, radiated and paralleled.
- Continuously adjustable brightness.
- Convenient quick recharging.
- Anti-overcharging function protects the battery.
- Connected with the head of ophthalmoscope is also available.
- Double electricity double sufficient power. YZ24B and YZ11D could be recharged at the same time.



技术参数 FEATURES

- Working Distance: 0.67m
 Streak width: 3mm-20mm
 Illumination Source: 3.5V/2.8W, Halogen Bulb
 Streak Rotation: 360°
 Power Supply: AC100V to 250V, 50Hz/60HZ
 Power (Main Body of Ophthalmoscope): Li+battery pack DC:3.7V



Indirect Ophthalmoscope

YZ-25C

间接检眼镜

- LED lamp(Low-temperature,low-pressure,high-brightness),the light is uniformly,bright and brightness can adjust continuously
- Imaging clearly,strong dimensional sense and large field of view range. The main body part of this device adopts engineering plastics, compact and exquisite.
- Surper lightweight design to reduce fatigue,operation is very convenient.
- The portable power is suitable for surgery, ward round and consultation.
- Equipped with color filter,teaching mirror and sclera depressor,operating be more handy.



YZ25C

You can obtain comfortable observation angle throw to adjust the multi-directional adjustment locking knob and lighting control knob.The color filter and the reflector are all the built-in dust-proof it can maintain long-term for the performance of clear illumination and observation.

Three kinds of color filter :White light,Cobalt blue light,Red-freelight.Three different- sizeds aperture:large aperture(60mm) medium-sized aperture(40mm),small aperture(20mm),it can suitable for diverse pupils.

The teaching mirror around two roads coating spectroscop,can observe distinctly and synchronous.



Eyepiece equipped with upper and lower fixtures allowing doctors to use more convenient.

Portable Teaching Tube, is small, compact and convenient to dismantle and assemble

Two kinds of sclera compressor with smooth surface, can effectively protect the tissue

Portable power battery

技术参数 FEATURES

- | | |
|-------------------------------------|---------------------------------------|
| Model: | YZ25C |
| Angle of View: | 45° ±5° |
| Pupil Distance: | 52mm~74mm |
| Weight: | 700g |
| Adjustable Range of the Head Frame: | 520mm~640mm |
| Depth: | 85mm~125mm |
| Illumination Source: | 6V/10W halogen bulb /LED |
| Power Supply: | AC110V/220V±10%, 50Hz/60Hz |
| | Lit battery pack DC:7.4V Rechargeable |

Optical Coherence Tomography

Retiview 500

光学相干断层扫描仪



All-in one Design



Compact Design

Everything is inside this compact body. No external computer is needed. Plug in the power cable, then you are ready to go.

PC Inside

Data acquisition and processing are accomplished by the internal computer. The data can be transported via ethernet or external harddrive. Peripheral devices, such as keyboard or printer, can be connected to the computer ports.

Easy Installation

No complex connection or set up. Compact body can fit in even small space.



Step 1

Choose left or right eye. Push the direction buttons to move the target eye to the center of the field of view, then start data acquisition.

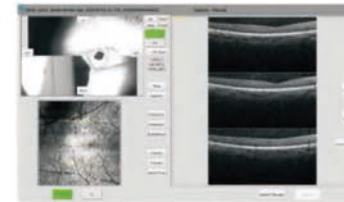

Step 2

Enter the data acquisition interface. The device is able to search for the OCT signal and optimize it automatically.

Simple Operation

Step 3

Browse and analyze the acquired images.

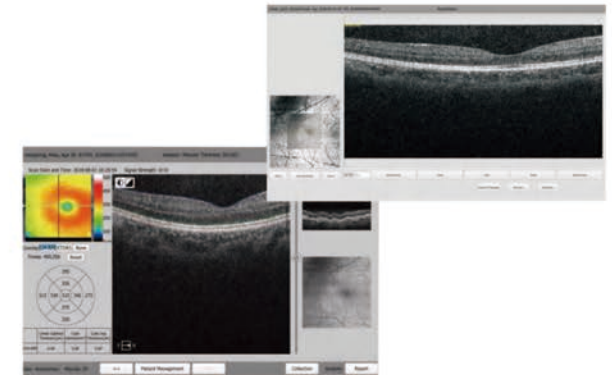

Affordable Quality

We believe that less is more. The simple design of Retiview 500 OCT reduces the cost of the device without sacrificing the image quality. OCT has never been so affordable. More people can benefit from the advanced technology now.

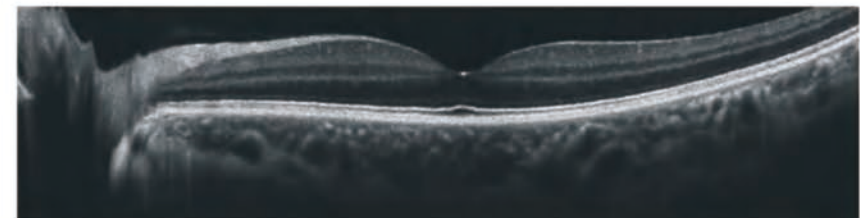

技术参数 FEATURES

Methodology: Spectral domain OCT
Axial resolution: $\leq 6 \mu\text{m}$ (in tissue)
Transverse resolution: $\leq 20 \mu\text{m}$ (in tissue)
Scan depth: $\geq 2.5\text{mm}$ (in air)
Scan range: $\geq 6\text{mm}$
Scan speed: $\geq 24,000$ A-scans/sec, up to $36,000$ A-scans/sec
Scan modes: 3D, Raster, Circle
Fundus image: OCT en face
Focus adjustable: $-15\text{D}+15\text{D}$

Pupil diameter: $\geq 3\text{mm}$
OCT light source: 840nm SLD
Optical power: $750 \mu\text{m}$ (at cornea)
Operation: $13.3''$ touch screen, optional external mouse or keyboard
Power supply: $100-240\text{V}, 50/60 \text{Hz}$
Dimensions: $497\text{mm} \times 395\text{mm} \times 490\text{mm}$ (L×W×H)
Weight: 34kg (75lbs)

Note subject to change without advanced notice.

Biometer

生物测量仪

AL-View



Step 1

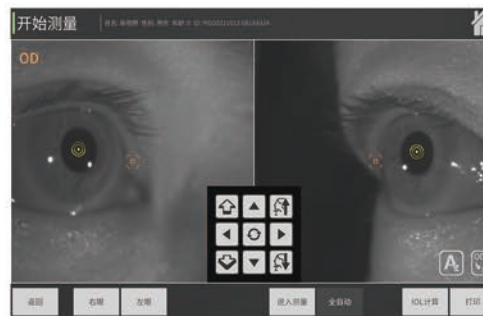

技术参数 FEATURES

Measuring Range	
axial length:	14-38mm
Corneal curvature:	5-11mm
Anterior chamber depth:	0.7-8mm
Lens thickness:	1-10mm(lens) 0.13-2.5mm(intraocular lens)
Center cornea thickness:	0.2-1.2mm
Cornea white to white:	7-16mm
Pupil diameter:	2-13mm
urvature range:	180 degree
Accuracy	
Axial length:	0.01mm
Corneal curvature:	0.01mm
Anterior chamber depth:	0.01mm
Lens thickness:	0.01mm
Center cornea thickness:	0.01mm
White to white:	0.1mm
Pupil diameter:	0.01mm
Axis of sight eccentricity:	0.01mm
Axis angle:	1 degree

Step 2



Step 3



Repeatability	
Axial length:	0.02mm
Corneal curvature:	(1ρ)+/-30um
Anterior chamber depth:	0.02mm
Lens thickness:	0.02mm
Center cornea thickness:	0.02mm
White to white:	(1a)+/-0.3um
curvature difference:	+9 degree
Calculation formula of intraocular lens	
BinkHorst-II, Holladay, Hoffer-Q, Haigis, SRK-T, SRK II	
interfaces	
USB 2.0	window 10
voltage/lfrequency	
AC 110-240V/50HZ	

Corneal Topography

角膜地形图

SW-6000



技术参数 FEATURES

Measuring Mode: Placido Cone

Coverage range of measurement: 10.91mm (Diameter)

Measuring range of Curvature radius:

5.5mm-10.0mm (33.75D-61.36D)

Precision: $\pm 0.02\text{mm}$

Placido Rings: 31 Rings

Measurement Points: 7936 Points

Display: Axial Curvature map, Tangential Curvature Map,

Elevation Map, Imitated Keratoscope Map and 3D cornea Map

Image output: High-Quality color inkjet printer

Ajust range: Left/Right>86mm;Forward/Backward>40mm;Up/

Down>30mm;Chinrest>50mm

Cornea Contact Lenses Fitting Function

Keratoconus Detection Function

SW-6000

Corneal Topography SW-6000 Adopt PLACIDO cone, 31 rings, a total of 7936 points.

Used in the clinical diagnosis of corneal astigmatism, quantitative analysis of corneal shape, display the corneal curvature by date or different colors, can display axial curvature map and corneal 3D map. Can be used in preoperative examination and postoperative effect evaluation of corneal refractive surgery, can guide wearing contact date lens, to improve the accuracy of adaptive contact lens

Rebound Tonometer

眼压计

SW-500



技术参数 FEATURES

- 1.Internal reading Lensmeter.
- 2.±25D measurement.
- 3.Wide field of vision observation.

Specifications

Ranges of Measurement: 0 to ±25D

Minimum:

Outer Reading:0.125D Inner Reading:0.125D graduation up 0 to ±5D and 0.25D graduations over ±5D to ±25D

Cylinder Axis Range: 0-180° step 1°

Prismatic Power Range:

0-5 prism diopters, graduations with prism compensation device

0~20 prism diopters, 1 graduations

Prism Base Angle: 0~180°

Eyepiece Adjustment: ±5D

Dimension of Objective Lens: 16~86mm

Overall size: 275×120×430mm

Weight: 4kg

Lighting Bulb: ~220V/-3V 3W or ~110V/-3V 3W

Applanation Tonometer

眼压计

YZ-30R



技术参数 FEATURES

The product is designed on the principal basis of Goldman tonometer. Three types are available: R and T Type are suitable for Haag Streit type slit lamp, while Z type is suitable for Carl Zeiss type slit lamp.

Character

It's not only used to examine the eyes, but also measure the intraocular pressure while working under the slit lamp.

Accurate measurement ensures the total tolerance less than ± 0.066KPa (0.5mmHg).

Directly get the intraocular pressure.

Measured intraocular pressure will not be affected by hardness of eye.

Adjustable measuring pressure ensures the working stability and accurate measurement of tonometer for long time.

Product Description

The instrument is designed based on Goldman tonometer. Both T type and R type are available.

- 1.When used with Slit Lamp, it can be used to examine the eyes and measure the ocular pressure.
- 2.Accurate measurement and total tolerance is less than 0.066KPa (0.55Hg)
- 3.Directly get the ocular pressure.
- 4.The measured ocular pressure is not affected by hardness of eye. The affected ocular volume is just 0.56 cubic millimeter.
- 5.Adjustable measuring ensures the long-term stability and reliability.

Model	YZ-30R
Measuring range	0 - 1064 KPa (0-8 mmHg)
Halo Displacement	1.53 × 2 = 3.06mm
Prism head diameter	7mm
Prism head range of activities	3mm
Model YZ-30R	
Measuring range:	0 - 1064 KPa (0-8 mmHg)
Halo Displacement:	1.53 × 2 = 3.06mm
Prism head diameter:	7mm
Prism head range of activities:	3mm

Air Tonometer

非接触眼压计

SK-5000A/B



Electric chin rest

Auto alignment
Auto focus

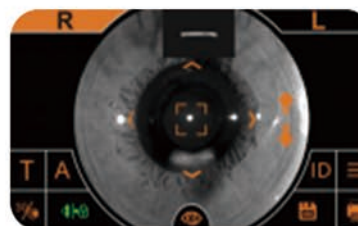
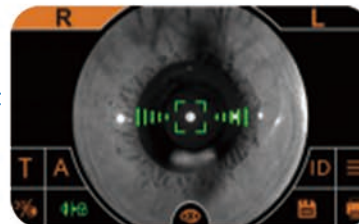

Corneal thickness measurement
Auto soft air puff

SK-5000A/B

Auto switch OS&OD

技术参数 FEATURES
Measurement mode: Fully automatic/Automatic/Manual
Corneal thickness measurement : Not support / Support
Measurement range-CCT:400-800um Measurement increment-CCT:10um Light Source:Blue LED
Display: 7-inch 1024*600 color touch screen, support up and down 180°,left and right 60° flip
Fixation light: 1 internal fixation light(green LED),2 external fixation lights
Measurement accuracy: 1mmHg(0.133Kpa)
Measurement range: 0-60mmHg(0-8Kpa)Include automatic switching between 30/60mmHg
Printer: Bulit-in thermal printer,automatic paper cutting
Date output/input: Input: USB; Output: LAN/RS232C
Size and weight: 500*300*500;<25kg



Fully automatic mode
One touch
You can get OS&OD date
It also supports semiautomatic/manual mode



SK-5000B supports corneal thickness measurement
More functions



Support air puff detection after turn on
Support safety limit setting
Safer equipment use and operation



7 inch color capacitive touch screen
Can be flip up and down 180°
Flip right and left 60°
Operation and observation are more convenient

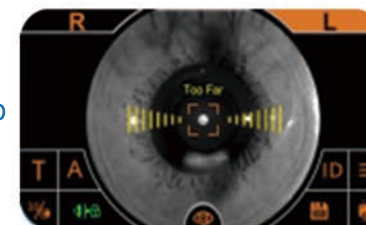

Print report
Auto paper cutting

Fundus camera

眼底相机

NES-1000



技术参数 FEATURES

Field of View: 42 degrees

Minimum Pupil: 2.5mm

Image Resolution: 1920*1080 (1080P)

Refractive Compensation: -20D~+20D

Focus Mode: Manual

Flash Mode: White LED/ Near Infrared LED

LCD Screen: 3.5-inch TFT Colored Screen

Picture Format: JPEG(Photograph)

Interface: Micro USB

Image Transmission: Micro USB , WIFI Transmission

Storage: Micro SD card. Maximum to 32G

Power: Li-on rechargeable Battery 3.6V/3400mAh

Size: 19cm*10cm*21cm

Net Weight: 400g (Typical)

Operating Time: 3h (under 2.5watts)

Charging Time: 5h

Output format: JPEG/AV

Power consumption: ≤6VA

The relative color temperature of the camera flash:

4500K≤TC≤6700K

Operating mode: Continuously

Resolution at the center of the field of view: ≥60 lp/mm

Resolution The middle of the field of view: ≥40 lp/mm

Resolution at the edge of the field of view: ≥25 lp/mm

Near - infrared spectral range: 800nm~880nm

White LED spectral range: 400nm~750nm

Packing size: 38*30*15cm

Fundus camera

眼底相机

HFC-2



RENDERINGS



技术参数 FEATURES

Transmission and storage:

internal capacity 16GB; USB/WIFI/BT/4G

FOV: 45°

Minimum pupil: 2.5mm

Weight: 560g

Refractive compensation: -20D~+20D

Power supply: Lithium Battery 3.7V 3400mAh

Focus way: Auto / manual/ real time auto focus

The battery continuously working time:

6h (Standby time exceeds 24h)

Fixation targets: 8 internal targets fixation

Image Video format: JPEG/3GP

Image resolution: 16MP

Operating system: PC: Windows system, APP: Android

Screen: 3.97-inch TFT-LCD, 800×480

ID Card reading and collection: Support

Shoot type: IR/White LED

NFC card reader: Support

Connect function:

Professional software, APP, support DICOM, support cloud service system, patient data management software, support wireless printing.

Packing size: 360*290*210mm

Fundus camera

眼底相机

Kestrel RC-3100m 小鹰1号



技术参数 FEATURES

Acquisition modes: Non-mydratric
Field of view: 53°
Working distance: 35mm
Focus modes: Auto/manual
Exposure mode: Auto/manual
Operation: Auto/manual
Photography: SLR camera
Resolution: 5megapixels
Diopter compensation: ±30D
Fixation: Internal fixation
Autofocus assistance: Dual camera
DICOM 3.0: YES
Customization AI port: YES
Dimensions: 380mm(L)×550mm(W)×475mm(H)
Weight: 26.5kg
Power supply: 100-240v 50/60HZ
Note: Specifications and design are subject to change without notice.

Quality first, HD image

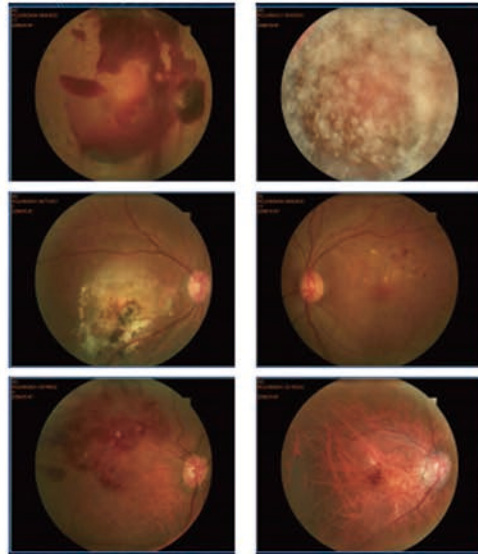

Multifunctional software system

*Powerful image processing function, acquire lesion area and cup disc ratio easily



Gamma, contrast, brightness, color of image can be adjusted, according to doctor requirement

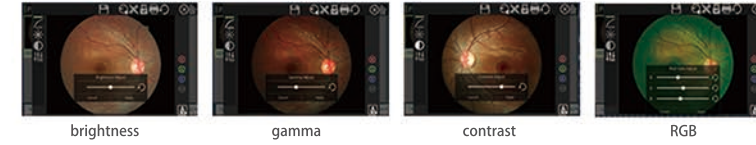

DICOM 3.0 LAN、USB expand port

- *Support DICOM agreement, connect hospital PACS system.
- *LAN sharing, any computer terminal can real-time display image taken by host.
- *USB expand storage.
- *Remote transmission via FTP system.



Intelligent operation

automatic /simple /fast

Automatic mode: automatic alignment and focusing, getting both eye high-definition images by one key touch.

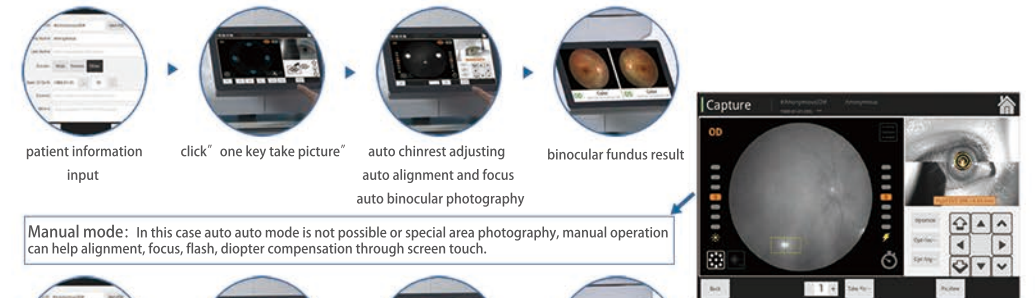

Manual mode: In this case auto auto mode is not possible or special area photography, manual operation can help alignment, focus, flash, diopter compensation through screen touch.

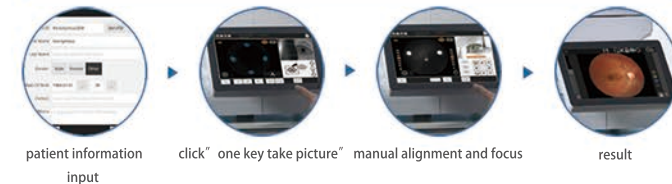



HONOR CERTIFICATE

**BRAND STRENGTH
AND RESPONSIBILITY**
品牌源自于实力 回归于责任

以严谨的态度创造高效工作，以科学的手段提供有效的数据，以优质的产品打造品牌。对比标杆找差距，把企业的目光紧紧盯住业界最好水平，明确自身与业界最佳的差距，不断寻求产品的改进与创新，为顾客提供优质的质量与服务。

Create efficient work with rigorous attitude, provide effective data with scientific means, and build products with high quality products.brand. Compare the benchmarks to find the gap, keep the company's eyes on the best level in the industry, and identify itself and the best in the industry. The gap, constantly seeking product improvement and innovation, to provide customers with quality quality and service.

INGENUITY IS AN ATTITUDE

匠心是一种态度，更是责任。



S H T O P V I E W ————— Specialized manufacturer of eyeglasses equipment